

Ultrason® E, S, P (PESU, PSU, PPSU)

Product Brochure



Ultrason® in the web: www.ultrason.de

 **BASF**
We create chemistry

Ultrason® E, S, P

The Ultrason® resins are amorphous thermoplastics derived from polyethersulfone (PESU), polysulfone (PSU) and polyphenylsulfone (PPSU) and offer very high resistance to heat. Their wide spectrum of beneficial properties allows them to be molded into high-quality engineering parts and high-load mass-produced articles. They can be processed by almost all the techniques adopted for thermoplastics. Ultrason® can be successfully used for applications in which other plastics, e. g. polyamide, polycarbonate, polyoxymethylene and polyalkylene terephthalates, fail to meet the requirements. By virtue of their extraordinary versatility, Ultrason® resins can substitute thermosets, metals and ceramics.

Ultrason® E, S, P (PESU, PSU, PPSU)

ULTRASON® IN AUTOMOTIVE CONSTRUCTION		4-5
ULTRASON® IN THE FOOD AND HOUSEHOLD SECTORS		6-7
ULTRASON® IN VARIOUS OTHER APPLICATIONS		8-9
THE PROPERTIES OF ULTRASON®		10 - 33
	Product range	10
	Mechanical properties	12
	Thermal properties	21
	Optical properties	24
	Aging in lubricants, fuels, and coolant fluids	25
	Electrical properties	28
	Fire behavior	29
	Resistance to chemicals	31
	Resistance to weathering	32
	Resistance to high-energy radiation	32
	Water absorption and dimensional stability	33
THE PROCESSING OF ULTRASON®		34 - 45
	General information	34
	Injection molding	35
	Extrusion	38
	Machining and postprocessing	42
GENERAL INFORMATION		46 - 50
	Safety notes	46
	Quality management	47
	Colors	47
	Delivery and storage	47
	Ultrason® and the environment	47
	Nomenclature	48
	Product overview	49
	Subject index	50

Ultrason® in automotive construction

Ultrason® E (PESU: polyethersulfone), Ultrason® S (PSU: polysulfone), and Ultrason® P (PPSU: polyphenylsulfone) are high-performance materials with a temperature profile that is unique among engineering thermoplastics.

Apart from its outstanding thermal stability, Ultrason® as a construction material has a lot of other performance characteristics that have led to a series of applications in the automotive and transportation sectors.

The key features for its successful application are:

- Short-term temperature resistance up to 220°C
- Long-term service temperatures up to 180°C
- Dimensional stability
- Creep strength at high temperatures
- Resistance to hot water and coolants
- Oil resistance, even at temperatures up to 170°C
- Fuel resistance
- Resistance to fluorine



Bezel for head lamp



Headlight bezel



Fuse encapsulation



Fog lamp housing

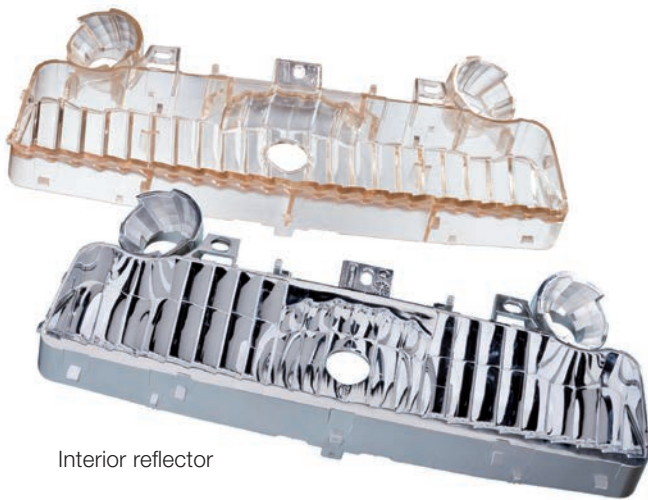

Interior reflector

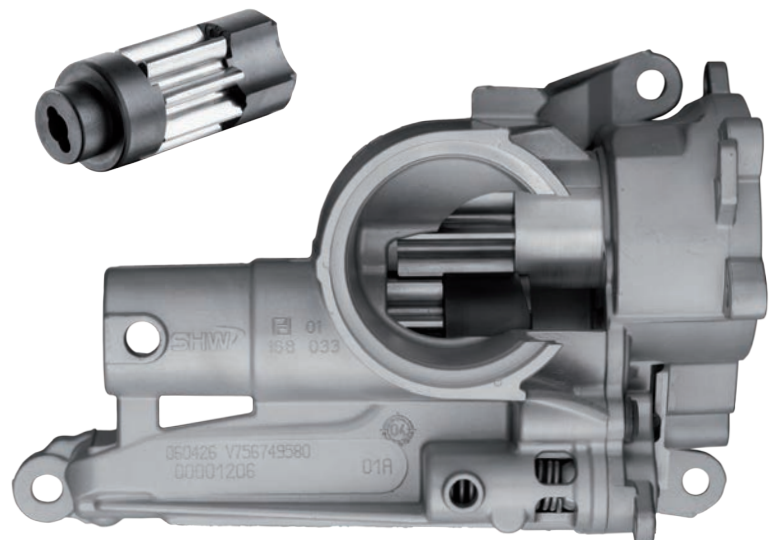

Oil pump with oil control piston

Ultrason® in the food and household sectors

Ultrason® E, Ultrason® S, and Ultrason® P are transparent, high temperature-resistant plastics. They are already used in apparatus engineering and in the electrical and electronics fields. In addition, there are many reasons for their use in the food and household sectors as a substitute for glass, metal, ceramic, and porcelain:

- Temperature resistance up to 180°C (short-term up to 220°C)
- Good mechanical properties, tough and impact-resistant
- High fracture resistance
- Transparent or opaque
- Exceptional chemical resistance
- Resistance to superheated steam
- Suitable for food contact

The typical plastics advantages of Ultrason® such as design flexibility, low-weight parts, fracture resistance, reusability, and recyclability offer appreciable savings in the overall system. These benefits also explain why Ultrason® is used to an increasing extent in applications that involve the preparation and reheating of hot meals.



Non-stick coated pan



Airplane dishes



Microwave dish



Fittings



Handpresso

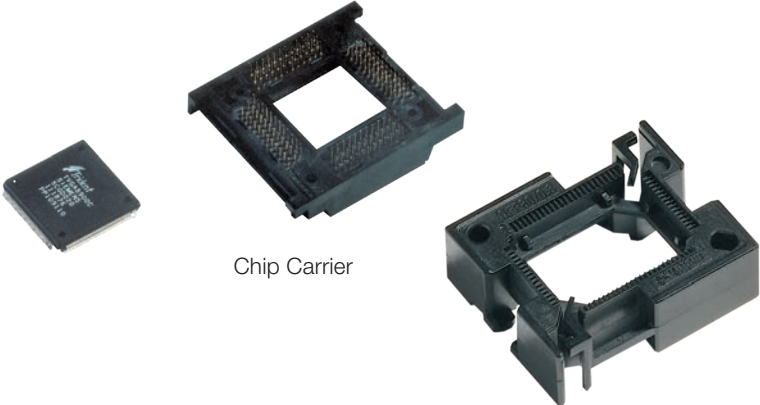

Chip Carrier

Ultrason® in various other applications

Ultrason® is especially suitable for highly stressed parts that must show substantial dimensional stability and good mechanical properties over a temperature range from -50 °C to +160 °C (Ultrason® S) or +180 °C (Ultrason® E and Ultrason® P), and that additionally require properties such as: good electrical insulation, high resistance to thermal aging, excellent fire behavior, and good resistance to chemicals and hydrolysis.

Examples of typical Ultrason® applications:

Electrical engineering and electronics

Coil formers, plug-and-socket connectors, printed circuit boards, circuit breaker components, parts for contactors and relays, viewing panels for signal lamps and switchboards, lamp bases and covers, heat shields, sensors, chip carriers, chip trays, and battery seals.

General apparatus engineering

Oil level indicators, discharge flow meters, pump components, automatic beverage dispenser components, milking machine parts, heat exchanger components, packing for absorption and distillation columns, seals, conveyor belt rollers, instruments, coverings, casings, surgical lighting fixtures, sterilization boxes, surgical secretion bottles, and filter membranes.

Heating and sanitary engineering

Heating circulation pump rotors, heating system thermostat components, hot-water meter components, interior components for sanitary fittings, and pipe fittings.

Environmental engineering

Membranes and filter housings, exhaust scrubbers.

Miscellaneous

Impact strength modifiers for composite materials (epoxy resins), and binders for high temperature-resistant coatings and nonstick coatings.



Filter membranes





Visor for fire helmet



Pump impeller



Functional parts

The properties of Ultrason®

Product range

Ultrason® is the trade name for the BASF product range including polyethersulfone (Ultrason® E), polysulfone (Ultrason® S), and polyphenylsulfone (Ultrason® P). It includes reinforced and unreinforced products for injection molding and extrusion, and powder products for solution processing, as shown in Table 13 (p. 49).

Details on the individual products can be found in the product range overview. Technical data on specialty and development products are available from the Ultra-Infopoint upon request.

Ultrason® E, S and P are amorphous, thermoplastic polycondensation products with the following basic structures:

Ultrason® E (Polyethersulfone, PESU)

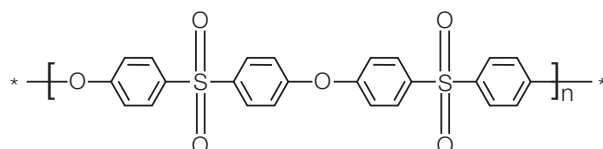

Ultrason® S (Polysulfone, PSU)

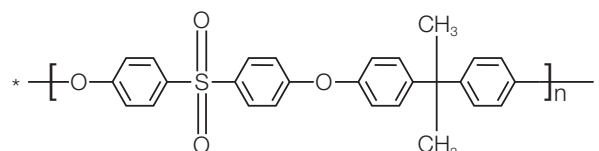

Ultrason® P (Polyphenylsulfone, PPSU)

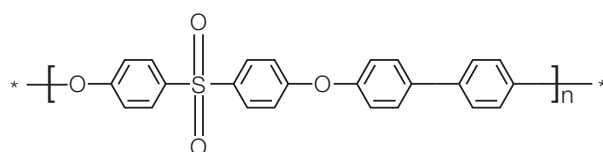

Fuse mounts

Ultrason® moldings have excellent dimensional stability and remain strong, rigid, and tough up to temperatures close to the glass transition temperature.

The key features of Ultrason® are:

- Temperature-independent properties
- Very high long-term service temperatures
- Good dimensional stability
- High stiffness
- High mechanical strength
- Good electrical insulation properties
- Favorable dielectric properties
- Very good fire behavior
- Excellent hydrolysis resistance

The figures quoted in this publication are standard values obtained from a representative number of measurements. They were determined with the cited testing methods on specimens that were prepared as laid down in the product standards or other stipulated regulations. They refer to uncolored material.

These standard values cannot be extrapolated to moldings of arbitrary geometry without reservation. As with other thermoplastics, the geometry of the molding and the processing conditions are of importance.

Ultrason® absorbs moisture from the air (see “Water absorption and dimensional stability”). Moisture absorption causes only slight dimensional change compared to the dry, freshly produced injection moldings, and leads to a marginal increase in impact strength, mainly in unfilled Ultrason® E products. Tensile strength and modulus of elasticity are only slightly affected.



Membrane for ultrafiltration

Mechanical properties

Behavior under short-term mechanical loads

Ultrason® is a plastic with high strength, stiffness, toughness, and substantial energy absorption capacity. By virtue of its amorphous structure, these properties are kept over a wide temperature range, extending from -50°C to values near the glass transition temperature. The shear modulus curves are shown in Fig. 1.

The addition of glass fiber increases the strength and stiffness, but reduces the ductility. Stress-strain diagrams at various temperatures are shown in Fig. 2 and Fig. 3.

The temperature dependence of strength and stiffness are shown in Fig. 4 to Fig. 7. Fig. 8 additionally shows the impact strength of reinforced and unreinforced Ultrason® in the range of -30°C to over 150°C. The remarkably high impact strength of Ultrason® P in injection molding applications compared to commercially available polycarbonate is shown in Fig. 9.

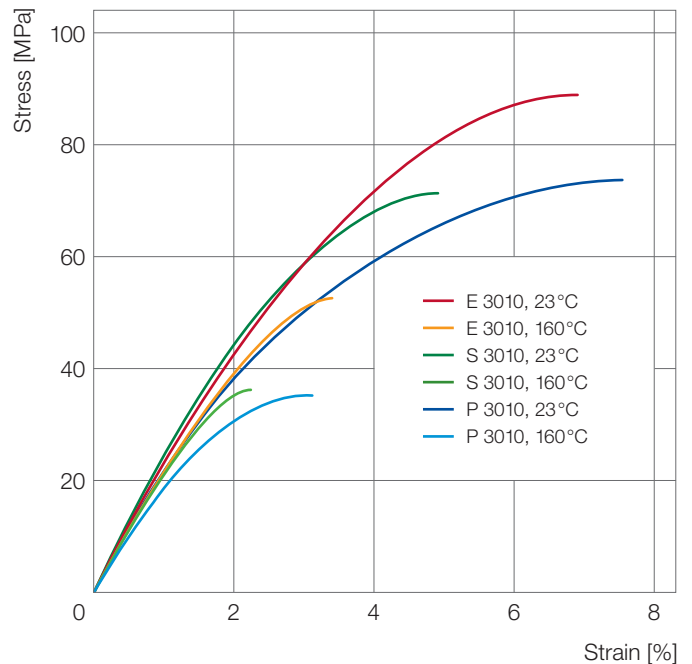

Fig. 2: Stress-strain diagrams according to ISO 527 up to the yield point, at RT and 160°C

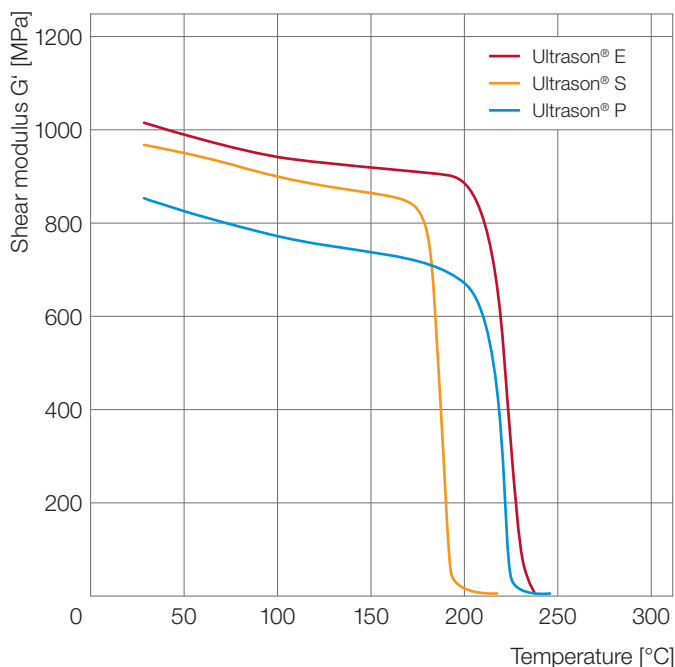

Fig. 1: Shear modulus curves according to ISO 6721

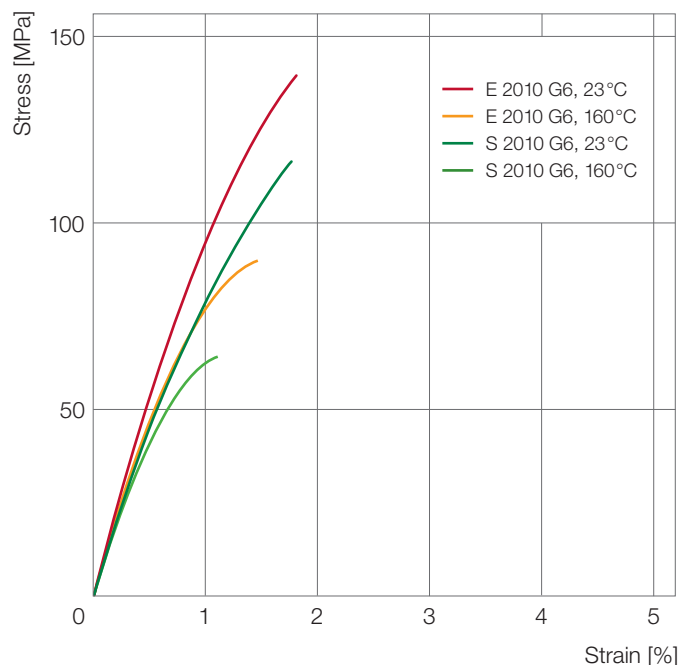

Fig. 3: Stress-strain diagrams according to ISO 527 up to the break point, at RT and 160°C

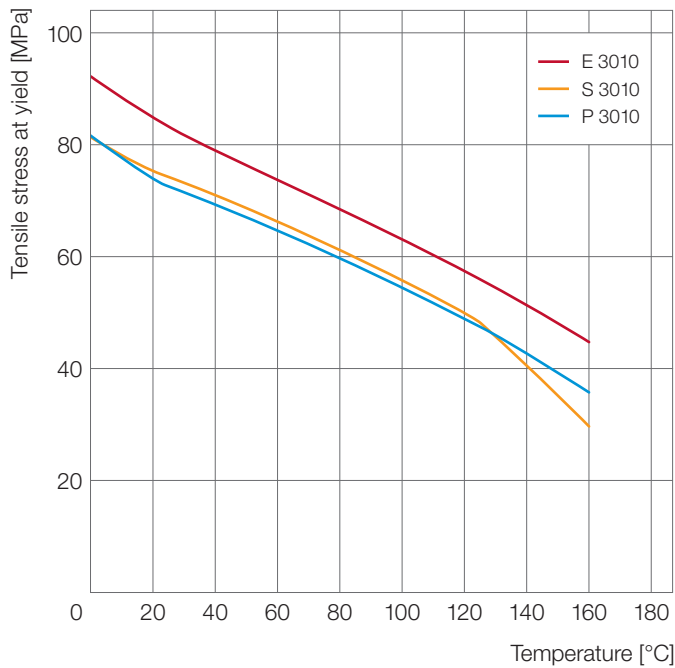

Fig. 4: Temperature dependence of the tensile stress at yield (dry)

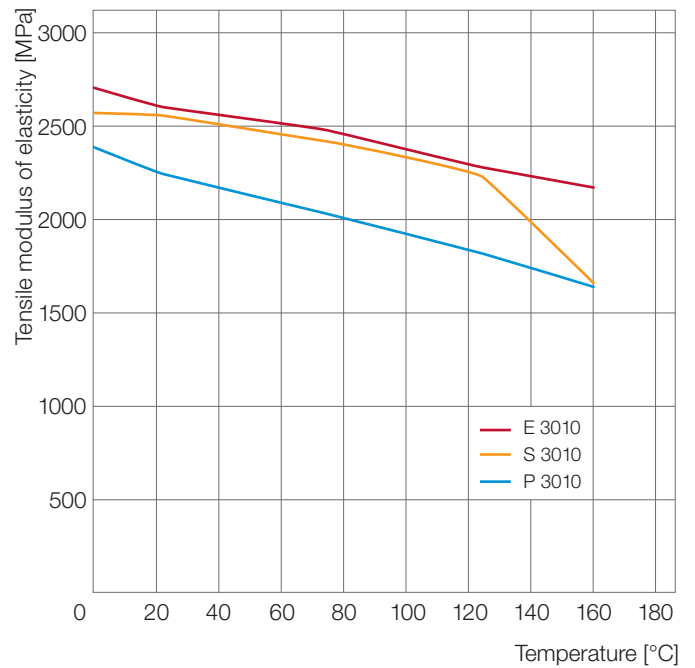

Fig. 6: Modulus of elasticity (according to ISO 527) as a function of temperature (dry)

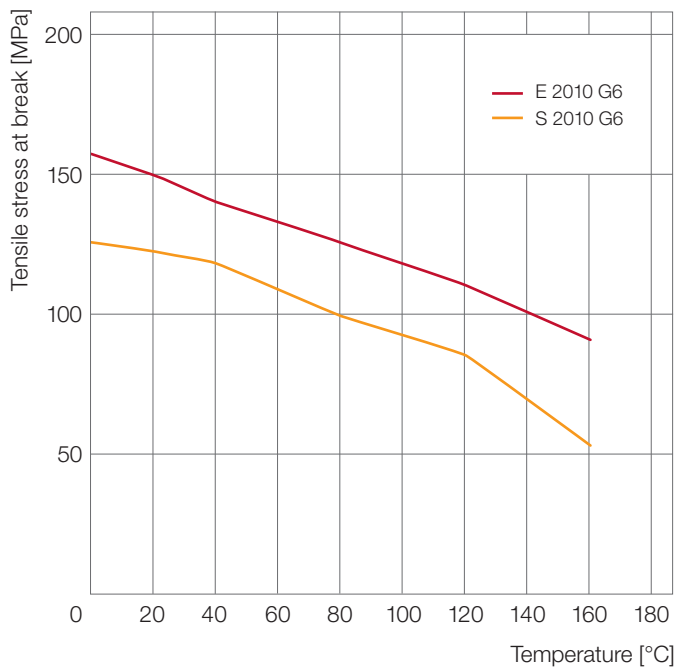

Fig. 5: Temperature dependence of the tensile stress at break (dry)

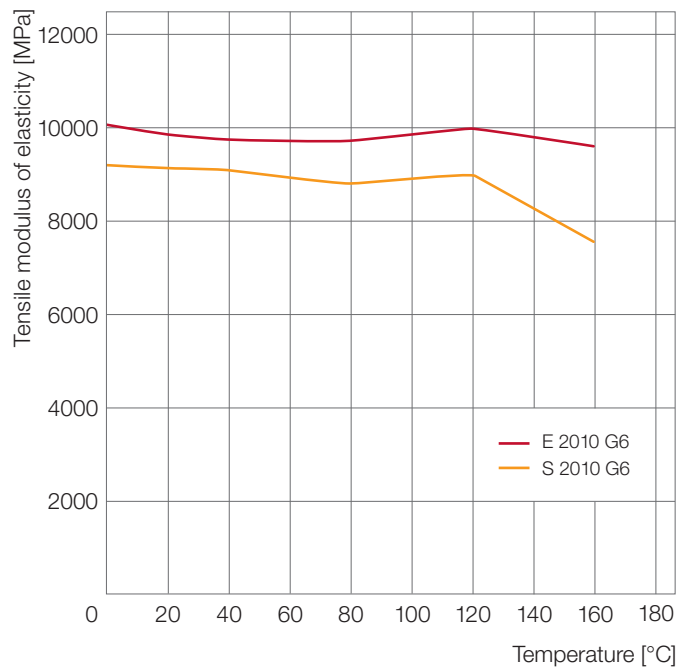

Fig. 7: Modulus of elasticity (according to ISO 527) as a function of temperature (dry)

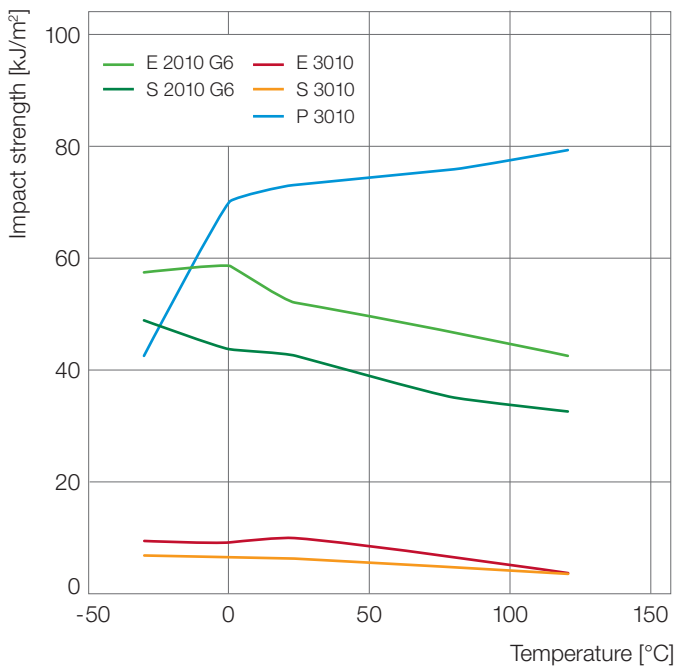

Fig. 8: Impact strength as a function of temperature (unnotched according to ISO 179/1eU with glass fiber-reinforced products, and notched according to ISO 179/1eA with unreinforced products)

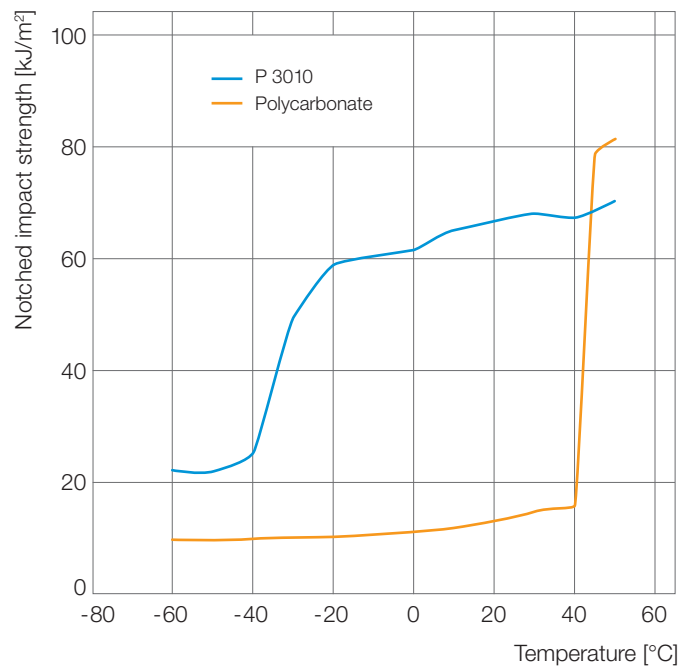

Fig. 9: Notched impact strength as a function of temperature (ISO 179/1eA); comparison of Ultrason® P with standard polycarbonate

Particularly with Ultrason® E or S, the excellent toughness and the associated high malleability can only be fully exploited in components of optimum geometry. To avoid notched transitions in the molding, significant changes in cross section require sufficiently large radiuses (recommended minimum radius of 0.4 mm). Internal edges, openings, and the like must be adequately rounded.

Behavior under sustained static loads

The performance of materials under static loads is tested by tensile creep experiments according to ISO 899. The material is subjected to constant stress for longer periods of time. The behavior of various Ultrason® products is shown in the following. Tensile bars were subjected to constant stress at defined temperatures for up to 10,000 hours. The elongation was measured over time.

The results are displayed as creep curves. The measured values were evaluated mathematically with the Findley equation. The Findley equation describes the elongation of materials with the following function:

$$\epsilon_{\text{total}} = \epsilon_0 + m \cdot t^n$$

$$m = m_0 + m_1 \cdot \sigma + m_2 \cdot \sigma^2 + m_3 \cdot \sigma^3 + m_4 \cdot \sigma^4 \dots$$

$$n = n_0 + n_1 \cdot \sigma$$

with σ = Creep stress

t = Time

ϵ = Elongation

The Findley equation is also used to extrapolate from the measured values to a time period of up to 100,000 hours. The extrapolation curve is shown as a dashed line in the diagrams.

Fig. 10 and following show the creep behavior at room temperature for the three unreinforced polymers Ultrason® E 3010, S 3010, and P 3010. Even under higher loads, all three polymers show very low creep. This is attributed to the much higher glass transition temperatures (T_g) for these materials relative to room temperature.

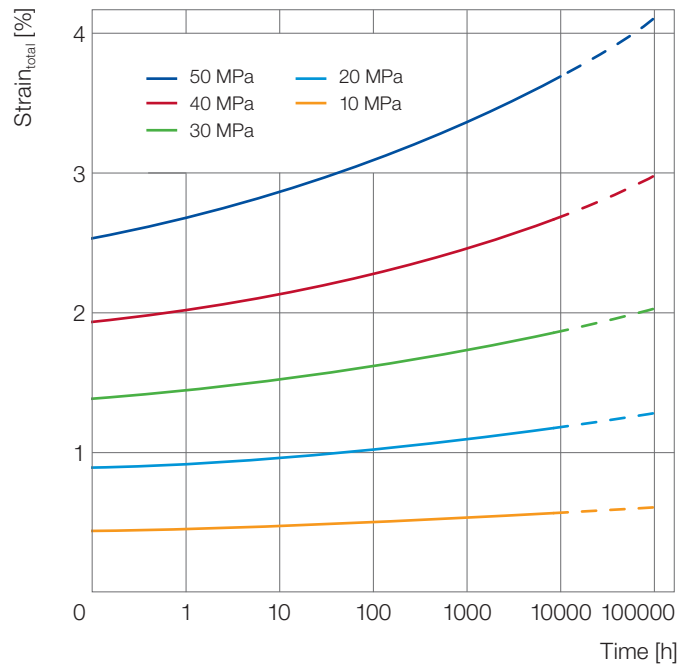

Fig. 11: Elongation-time curves according to ISO 899 for Ultrason® E 3010 at 23°C

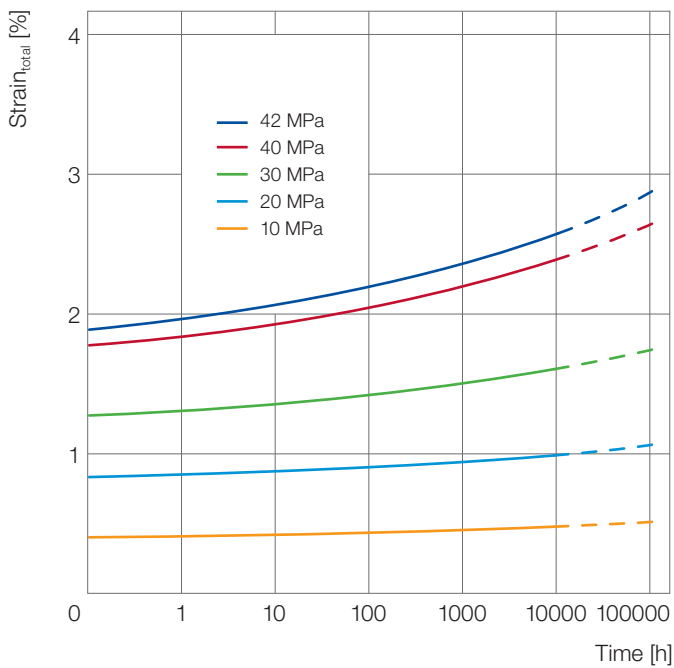

Fig. 10: Elongation-time curves according to ISO 899 for Ultrason® S 3010 at 23°C

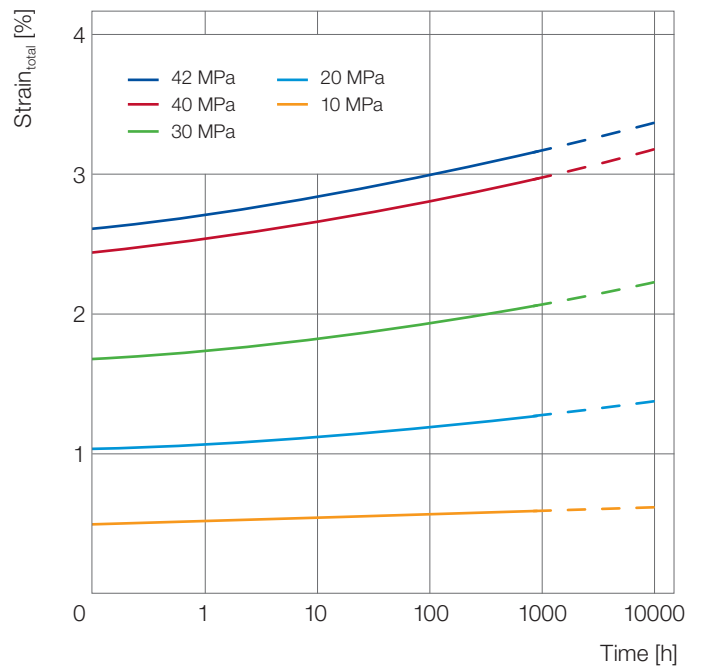

Fig. 12: Elongation-time curves according to ISO 899 for Ultrason® P 3010 at 23°C

Even at 140°C and 180°C (Fig. 13ff.), relatively high stresses can still be tolerated as compared with other unreinforced polymers, especially in the case of Ultrason® P and Ultrason® E due to their glass transition temperatures of 220°C or 225°C, respectively. The creep behavior, however, increases significantly relative to room temperature.

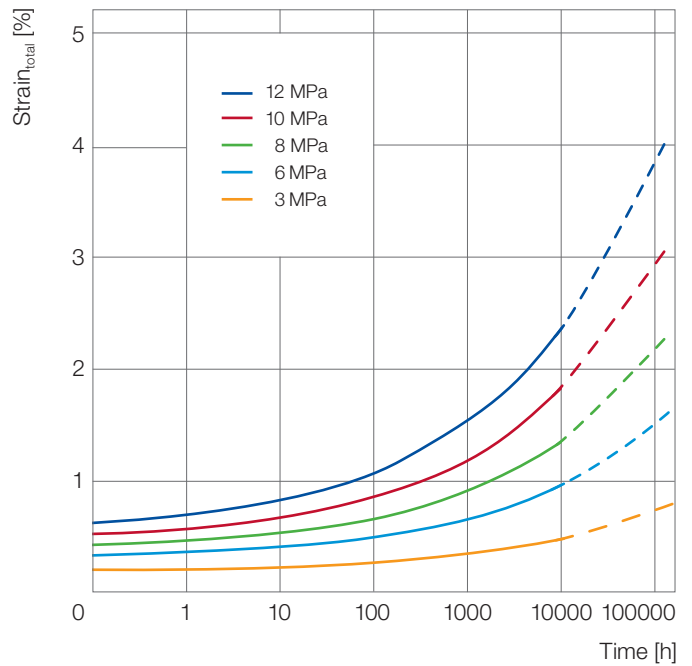

Fig. 14: Elongation-time curves according to ISO 899 for Ultrason® E 3010 at 180°C

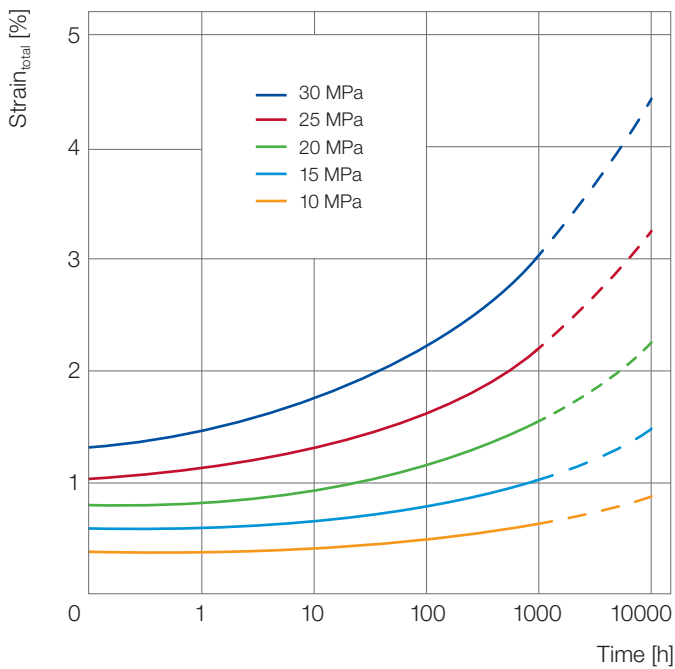

Fig. 13: Elongation-time curves according to ISO 899 for Ultrason® E 3010 at 140°C

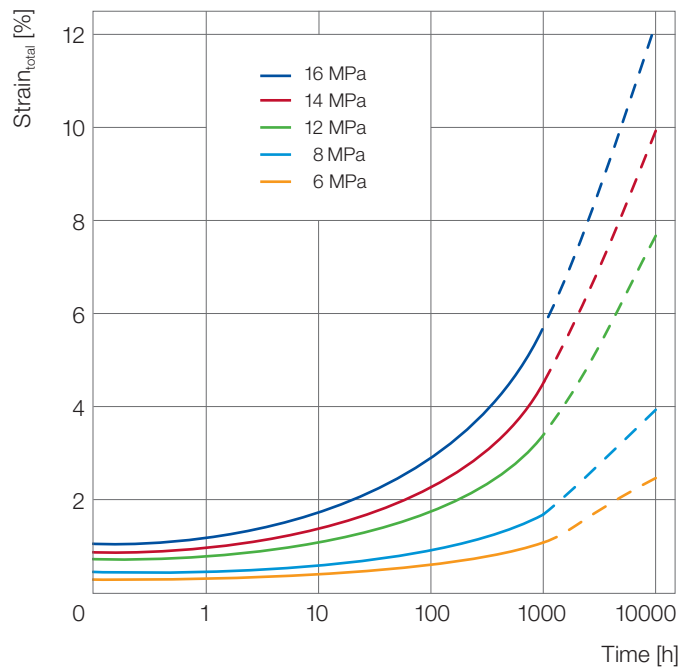

Fig. 15: Elongation-time curves according to ISO 899 for Ultrason® P 3010 at 180°C

A significant reduction in creep and higher loads are possible with the use of fiber-reinforced products (Fig. 16ff.). The elongation of the carbon fiber-reinforced product Ultrason® E 2010 C6 only amounts to about one percent, even under a load of 130 MPa after 10,000 hours.

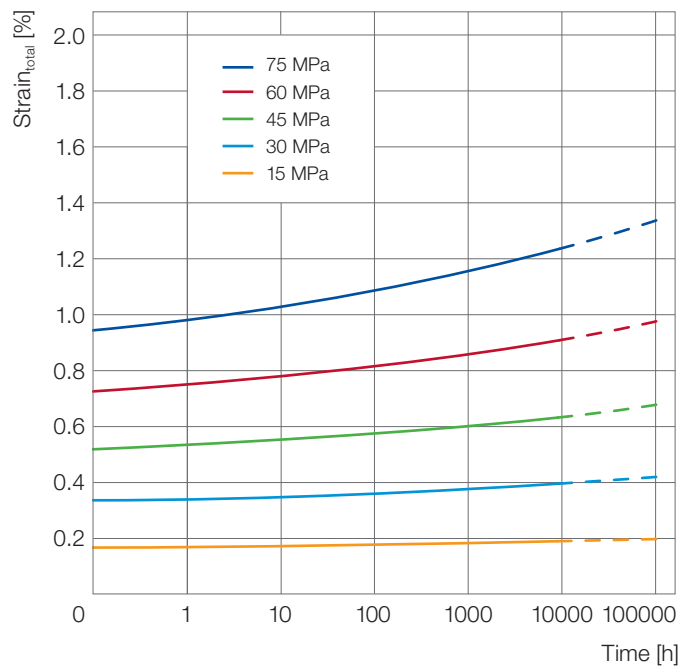

Fig. 17: Elongation-time curves according to ISO 899 for Ultrason® E 2010 G6 at 23°C

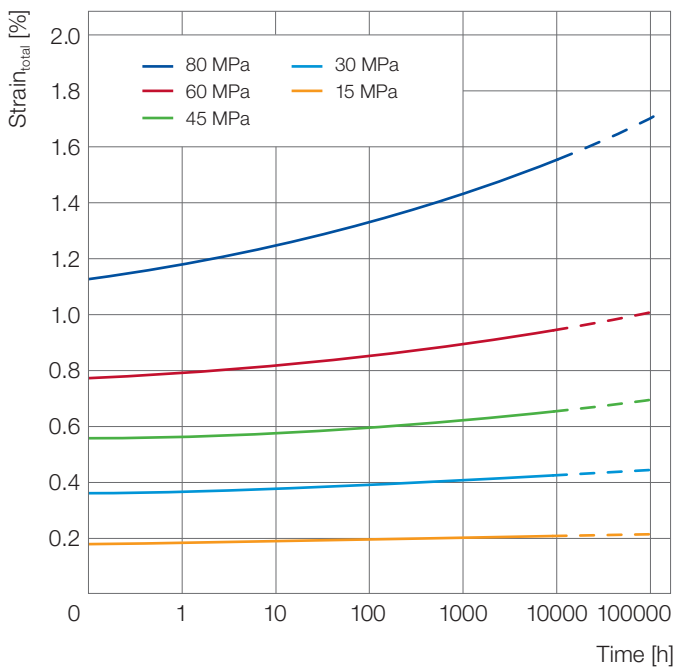

Fig. 16: Elongation-time curves according to ISO 899 for Ultrason® S 2010 at 23°C

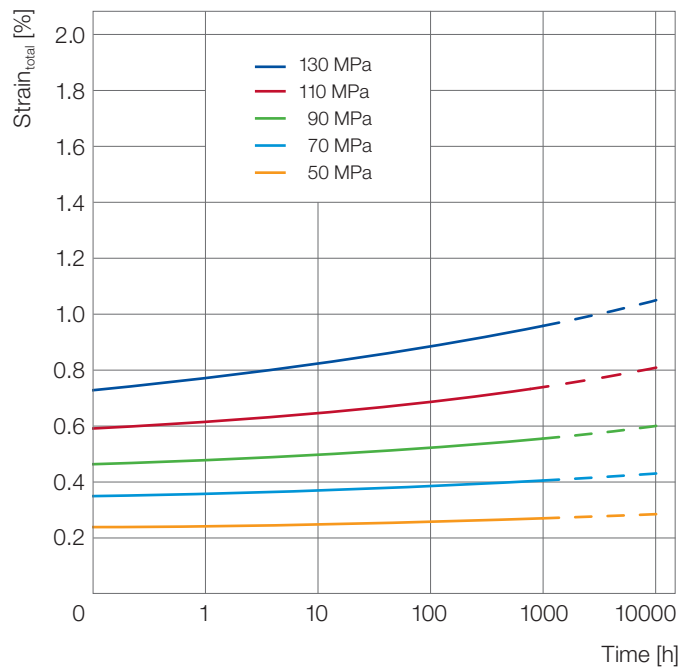

Fig. 18: Elongation-time curves according to ISO 899 for Ultrason® E 2010 C6 at 23°C

Fiber-reinforced products are characterized by especially low creep, even at elevated temperatures (Ultrason® S 2010 G6 at 140 °C and Ultrason® E 2010 G6 at 180 °C, Fig.19 ff.).



Headlight cover frame

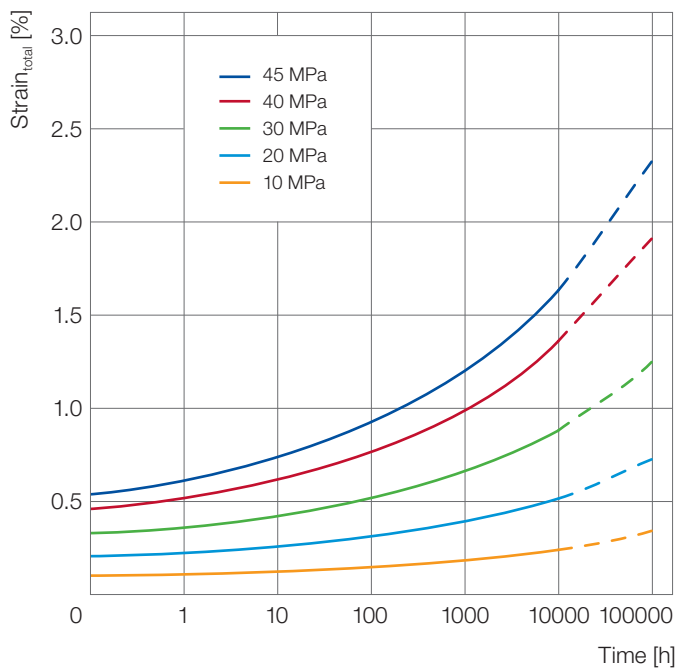

Fig. 19: Elongation-time curves according to ISO 899 for Ultrason® S 2010 G6 at 140 °C

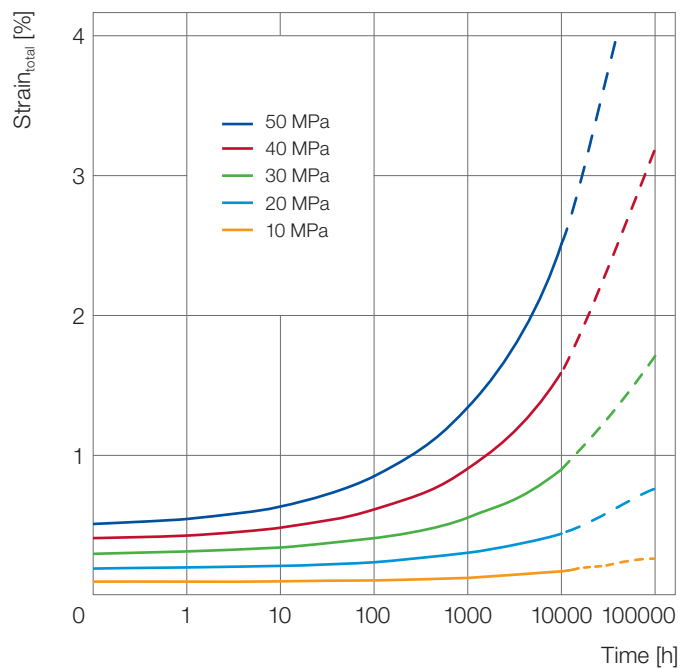

Fig. 20: Elongation-time curves according to ISO 899 for Ultrason® E 2010 G6 at 180 °C

Behavior under dynamic loading and flexural strength

Engineering parts are frequently subjected to dynamic forces, primarily in the form of cyclic or dynamic loading, by which structural components are periodically affected in the same manner. The response of a material to such stresses is determined by flexural fatigue testing (DIN 53442) up to very high numbers of load cycles. The results are presented in Wöhler diagrams, which are compiled by plotting the applied stress against the number of load cycles.

While translating such test results into actual applications, it must be taken into account that the material can heat up substantially at high load cycle frequencies due to internal friction. In these cases, as at higher operating temperatures, lower flexural strength values have to be assumed.

Fig. 21 shows the strength under dynamic loading for unreinforced and reinforced Ultrason® E, both at room temperature and at 180°C. Especially remarkable is the very limited decline at higher temperatures with glass-fiber reinforced materials. Fig. 22 shows the Wöhler curves at room temperature for Ultrason® S.

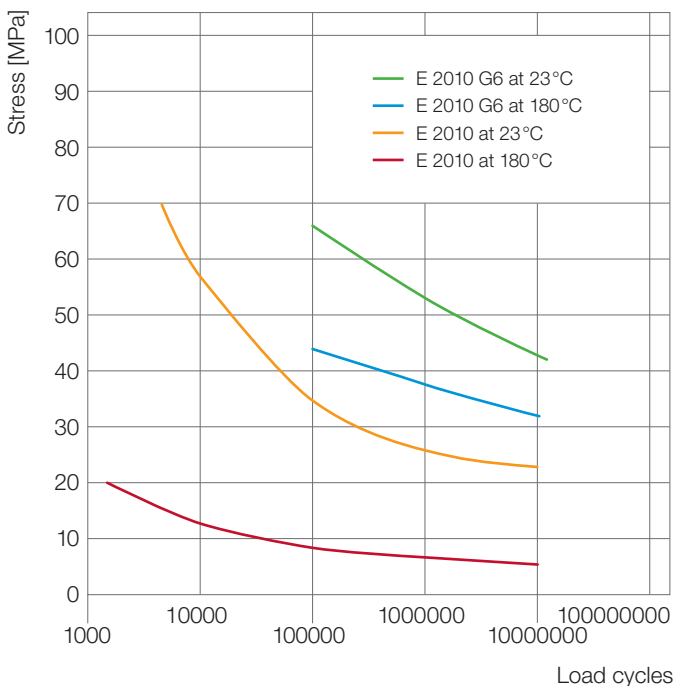

Fig. 21: Wöhler diagram for Ultrason® E 2010 and E 2010 G6 at 23°C and 180°C

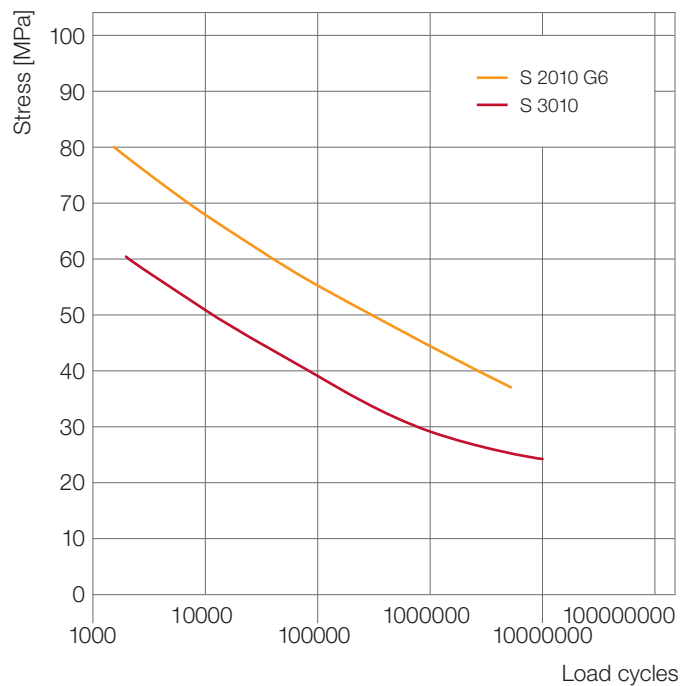

Fig. 22: Wöhler diagram for Ultrason® S 3010 and S 2010 G6 at 23°C

Friction and wear behavior

Friction and wear are system properties and not properties of a single material. The tribological behavior of systems cannot be characterized by parameters derived from the involved pure substances. Friction and wear are affected by a multitude of parameters, e.g., the nature of the sliding partner, the microstructure of the sliding surface (roughness), the intermediates (lubricants), the ambient medium, the surface pressure, and the relative velocity of the sliding partner.

Tribological tests nevertheless permit a general estimation of material behavior. In order to evaluate wear behavior pin-on-disk tribometers can be used, among other things.

As is known from amorphous thermoplastics, unreinforced Ultrason® products typically show poor sliding friction behavior. The wear properties can be significantly improved by adding fillers. Glass-fiber reinforced Ultrason® can be used in applications with lubrication in certain cases. For particularly critical wear requirements (applications without lubrication or in slip-stick situations) the Ultrason® E product range comprises with Ultrason® KR 4113 a material with optimized sliding friction behavior. Through carbon fibers, graphite, and PTFE, this material shows especially favorable tribological properties. Ultrason® E 2010 C6, reinforced only with carbon fibers, is another alternative. Compared with unreinforced or glass-fiber reinforced types, both materials show a significantly lower wear behavior in pin-on-disk tests when in contact with aluminum without lubrication (Fig. 23).

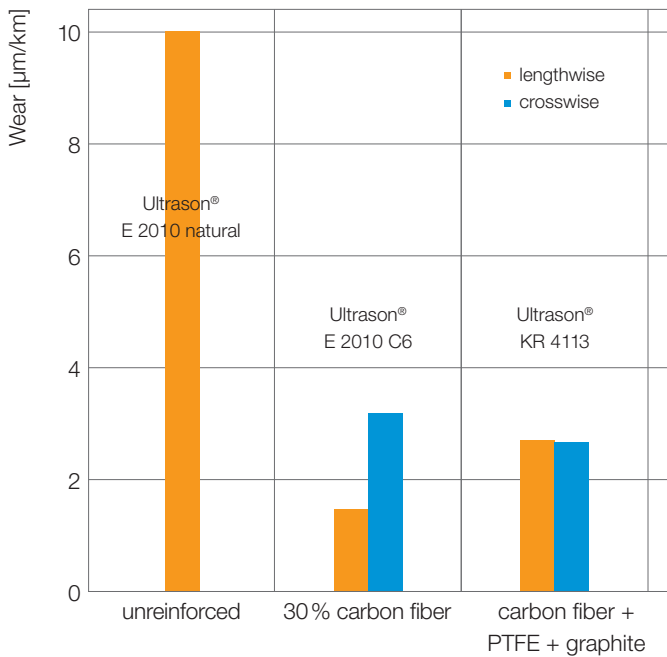
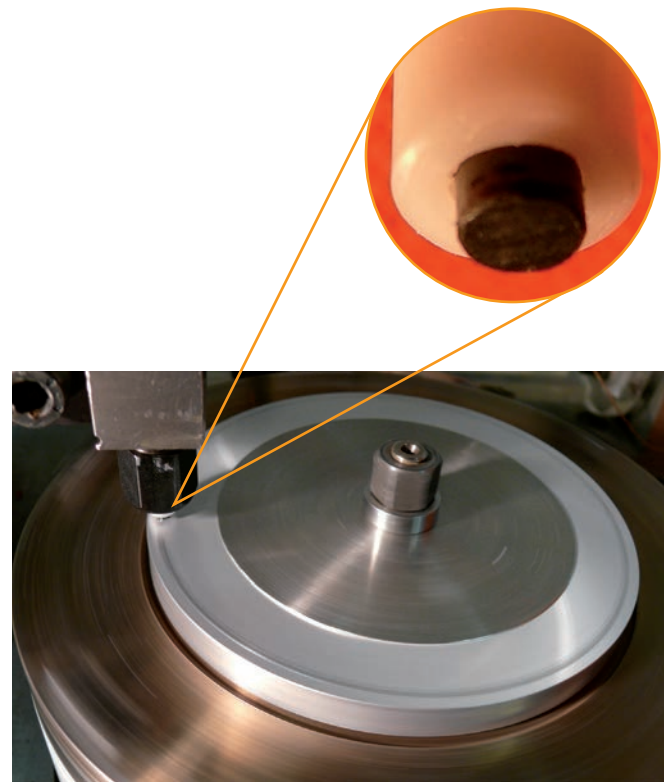

Fig. 23: Wear behavior
Tribological system: pin-on-disk apparatus, surface pressure $p = 1 \text{ MPa}$, base material aluminum with $6.7 \text{ }\mu\text{m}$ roughness (dry)



Thermal properties

The Ultrason® products have high glass transition temperatures, with 187 °C for Ultrason® S, 220 °C for Ultrason® P, and 225 °C for Ultrason® E. Ultrason® remains dimensionally stable up to the vicinity of the glass transition temperature.

The coefficient of linear thermal expansion stays at a very low level up to about the glass transition temperature, and is only marginally dependent on temperature. For unreinforced products, the coefficient of linear thermal expansion is approximately $55 \cdot 10^{-6}/K$ (Fig. 24). The reinforced products are characterized by even lower coefficients, and they consequently show still better dimensional stability when subject to changes in temperature. The linear expansion of glass-fiber reinforced products depends on the orientation of the fibers.

Behavior under the influence of temperature

The behavior of components made of Ultrason® when exposed to heat and various media depends on the duration and type of the temperature influence, the mechanical load, and the design of the components, in addition to the actual thermal properties of the specific product. Consequently, the stability of components made of Ultrason® cannot be readily predicted based on the specific temperature data obtained in various standard tests, no matter how valuable these figures may be as a guide and for comparison purposes.

The effect of elevated temperatures on the mechanical properties of Ultrason® is discussed in detail in the section "Mechanical properties." The dimensional stability under heat, as measured according to ISO 75-2 (HDT A), is about 175 °C for Ultrason® S, about 207 °C for Ultrason® E, and about 196 °C for Ultrason® P. Short-term heating to higher temperatures is possible, e. g., with specific soldering techniques. It should be noted, however, that only dry components should be subjected to these high temperatures because of the risk of vapor bubbles forming in moist components.

Resistance to thermal aging in air and water

Ultrason® possesses excellent resistance to thermal aging or thermal stability in air. The relative temperature index values measured according to UL 746 B are 155 °C for Ultrason® S and 190 °C for Ultrason® E. This temperature, defined as the storage temperature at which the tensile strength drops to 50 % of its initial value after a period of 20,000 hours, can in many cases be considered as the maximum long-term service temperature. If there is exposure to impact loads, the relative temperature index is about 10 °C less.

Immersion in cold water has practically no aging effect. Ultrason® is highly resistant to hydrolysis, even in boiling water or superheated steam, although a certain effect on its toughness can be observed.

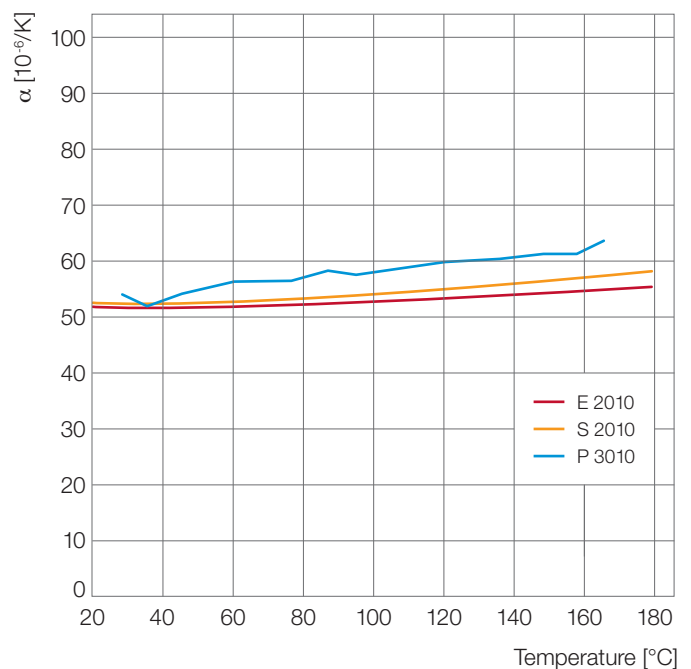

Fig. 24: Coefficient of linear thermal expansion according to DIN 53752

The behavior of Ultrason® under static load in water at 95 °C is shown in Fig. 25 and Fig. 26. Measurements on standardized specimens can only indicate the behavior of a molding under comparable conditions. Especially for applications in the presence of media, therefore, tests should be conducted on moldings that are subjected to similar conditions as during the use of the component.

Valuable information on the possible use of Ultrason® P in hot-water applications is given, for example, by the long-term internal pressure test according to ISO 9080 (Fig. 27). On the basis of this data, the maximum service life of water-carrying components such as the plastic fittings used in drinking water pipes can be predicted at various temperatures and pressures.

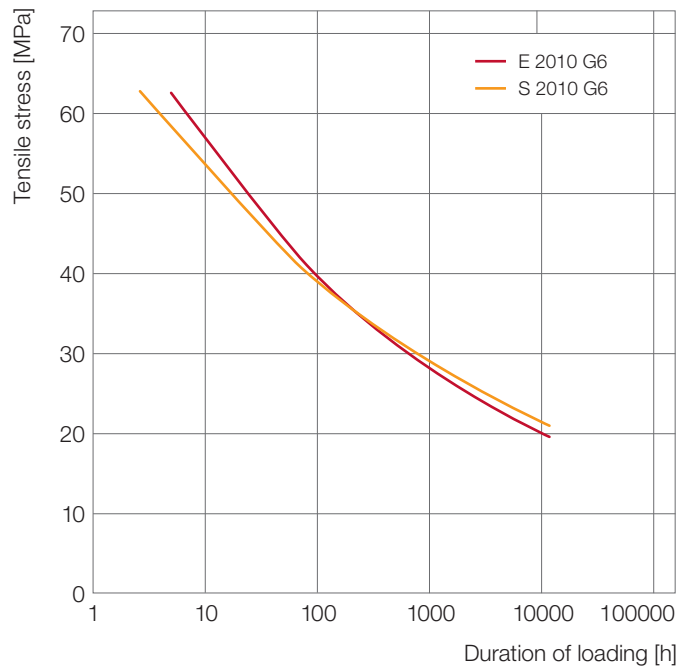

Fig. 26: Creep strength of glass-fiber reinforced Ultrason® in water at 95 °C

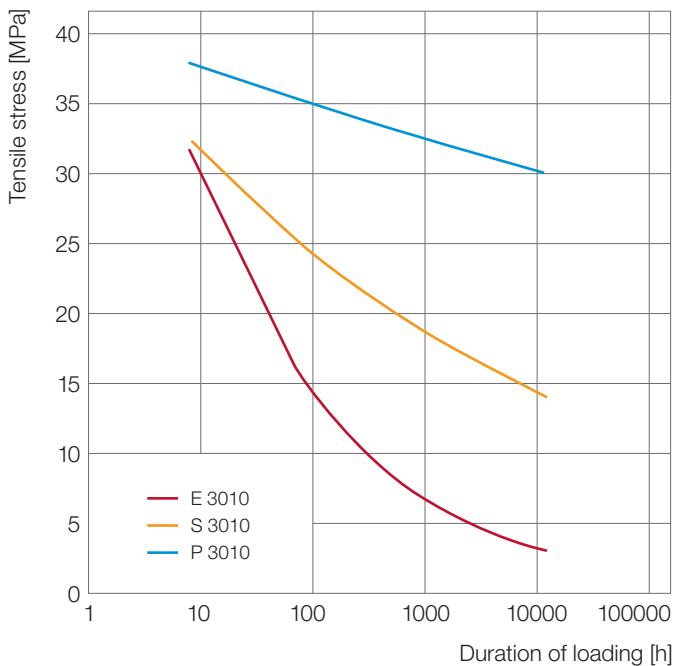

Fig. 25: Long-term hydrostatic strength of Ultrason® in water at 95 °C

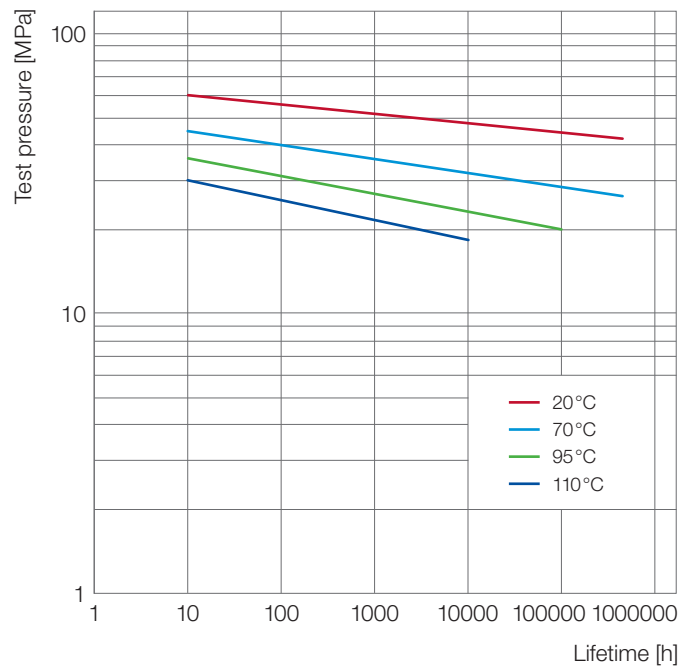

Fig. 27: Long-term hydrostatic strength for Ultrason® P at various temperatures (ISO 9080)

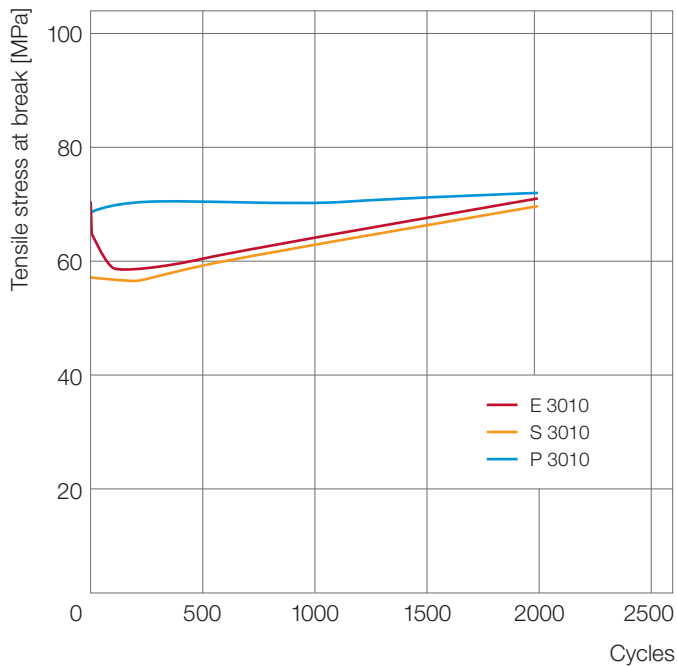

Fig. 28: Superheated-steam sterilization of Ultrason® at 134°C

Superheated-steam sterilization

Components made of Ultrason® can be repeatedly sterilized in superheated steam and largely retain both their transparency and their high level of mechanical properties (Fig. 28). Ultrason® P performs extremely well in this case, since its toughness and elongation at break changes very little over many sterilization cycles (Fig. 29).

The suitability for superheated-steam sterilization increases in the following order: Ultrason® E < Ultrason® S < Ultrason® P.

To counteract stress cracking, the level of residual stress in the components should be kept as low as possible during manufacture (see “Injection molding”).

Likewise, products with the highest possible viscosity should be used. In components made of Ultrason® S and Ultrason® E, mechanical stress during sterilization should be avoided. Thus, up to 100 sterilization cycles are possible. Ultrason® P shows such extremely high resistance to stress cracking that even 2,000 superheated-steam sterilization cycles under load are possible without any crack formation.

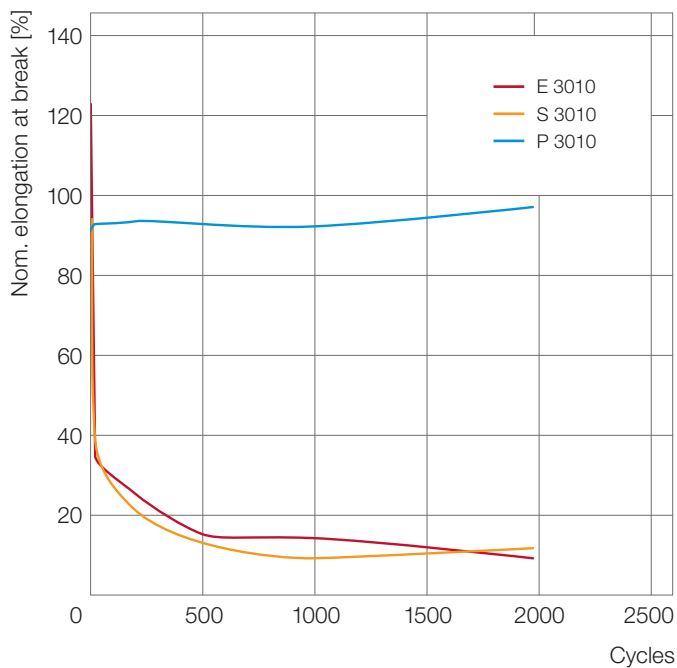
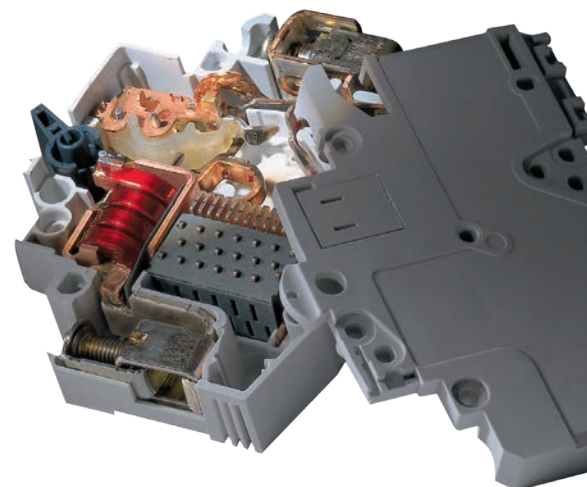

Fig. 29: Superheated-steam sterilization of Ultrason® at 134°C



Latches for circuit breakers

Optical properties

As amorphous thermoplastics, the three Ultrason® polymers are transparent. Due to the high temperatures necessary during their manufacture and processing, however, they acquire a certain coloration (light golden-yellow to ocher) that prevents the theoretically possible transmittance values for visible light. The qualities that are achieved today are nevertheless suitable for many applications that require transparency (Fig. 30). In addition, Ultrason® shows high refractive indices in the visible wavelength range, which makes it suitable for applications in functional optics, such as lenses for electronic cameras (Fig. 31).



Firefighter's helmet

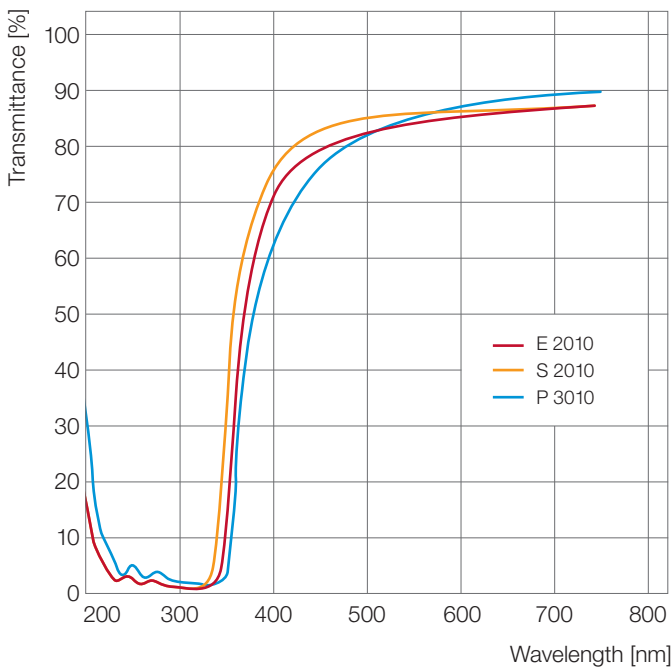

Fig. 30: Transmittance properties of Ultrason® (2 mm disks)

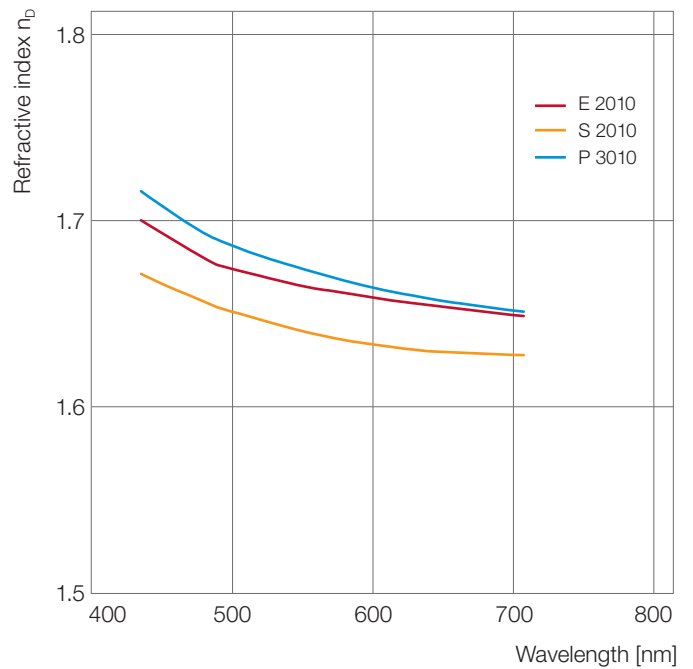

Fig. 31: Refractive index of Ultrason® as a function of the wavelength (2 mm disks)

Aging in lubricants, fuels, and coolant fluids

The requirement for the many technical applications of Ultrason®, especially in the automotive industry, is its remarkable long-term stability in the presence of hot lubricants, fuels, and coolant fluids. Ultrason® KR 4113 is widely used in motor vehicle oil circulation systems (oil pumps and oil flow regulators). Fig. 32ff. show the stability of this material in the presence of motor oil (new and used) at 150°C. The elongation at break and impact strength were selected for this example.

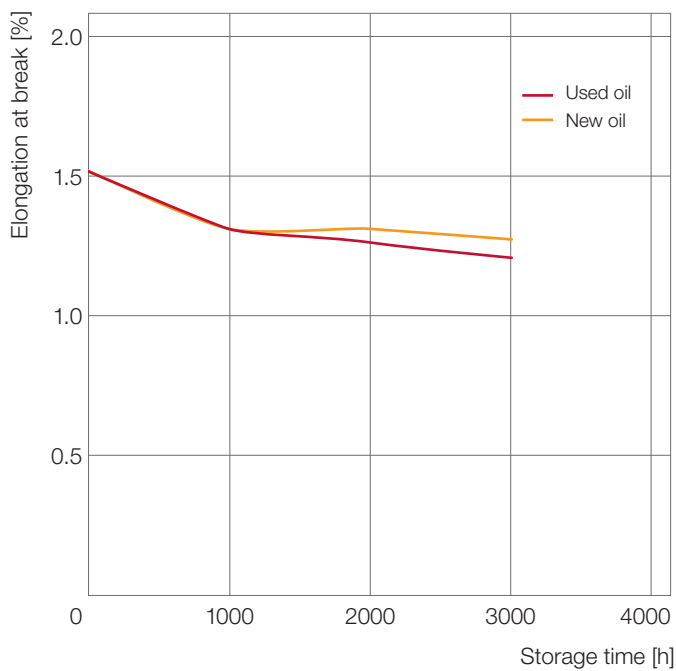

Fig. 32: Stability of Ultrason® KR 4113 in Total 5W30 motor oil at 150°C

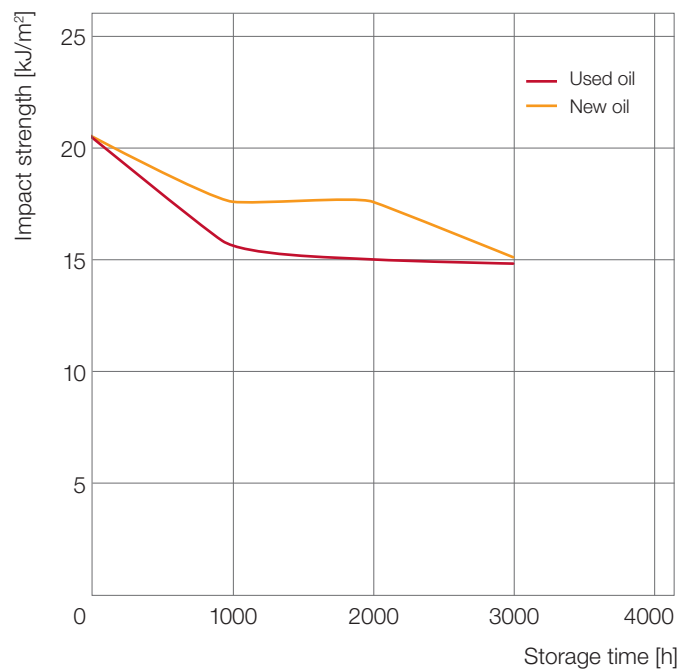
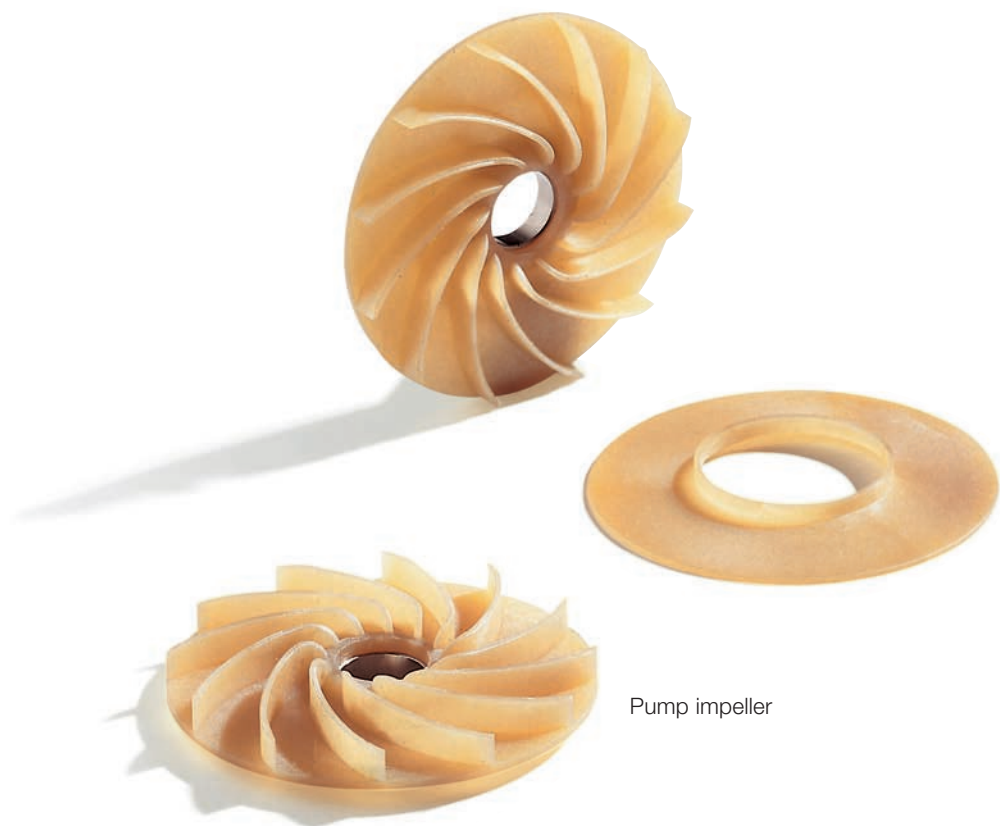

Fig. 33: Stability of Ultrason® KR 4113 in Total 5W30 motor oil at 150°C

The test gasoline FAM B frequently poses a challenge for materials. Fig. 34 ff. show that Ultrason® P in particular, but also Ultrason® E, show good to very good stability in this case. Ultrason® E, and most of all Ultrason® P, are suitable for functional components in motor tanks, e.g., tank inserts. On the other hand, Ultrason® S is not stable with FAM B.

A glycol/water mixture can be used as a model for cooling fluids. Also in this motor vehicle-related system, Ultrason® E and Ultrason® P demonstrate good stability (Fig. 36). In general, the glass-fiber reinforced Ultrason® products show significantly more favorable behavior characteristics concerning stability to media as compared to the respective, unreinforced base materials, so that additional potentials exist in this regard.



Pump impeller

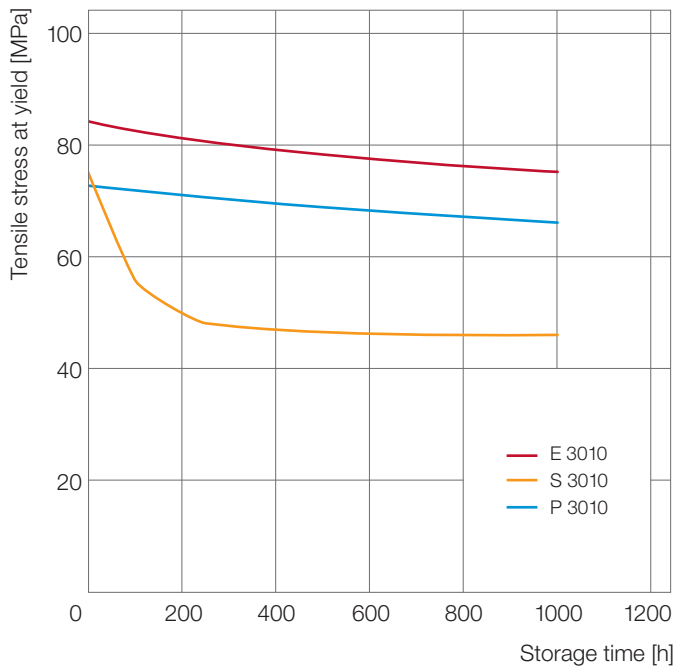

Fig. 34: Stability of Ultrason® in the presence of FAM B at 23°C

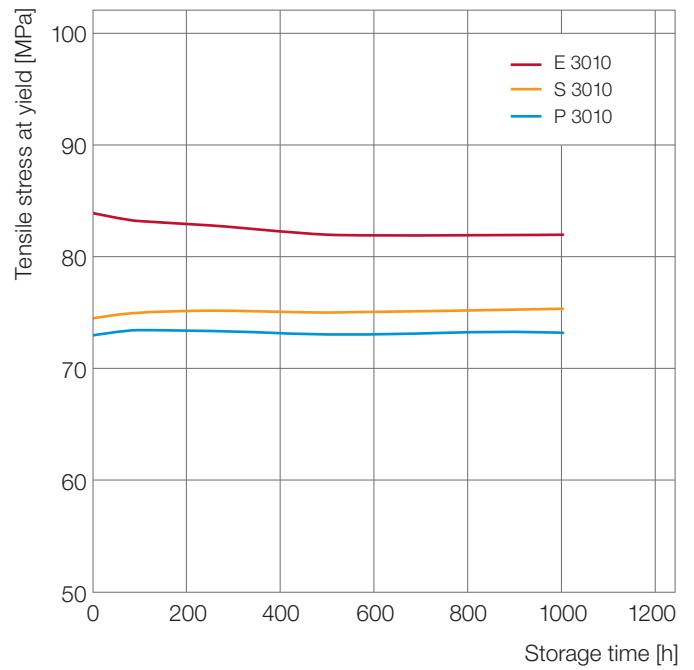

Fig. 36: Stability of Ultrason® in the presence of glycol (50% in water) at 23°C

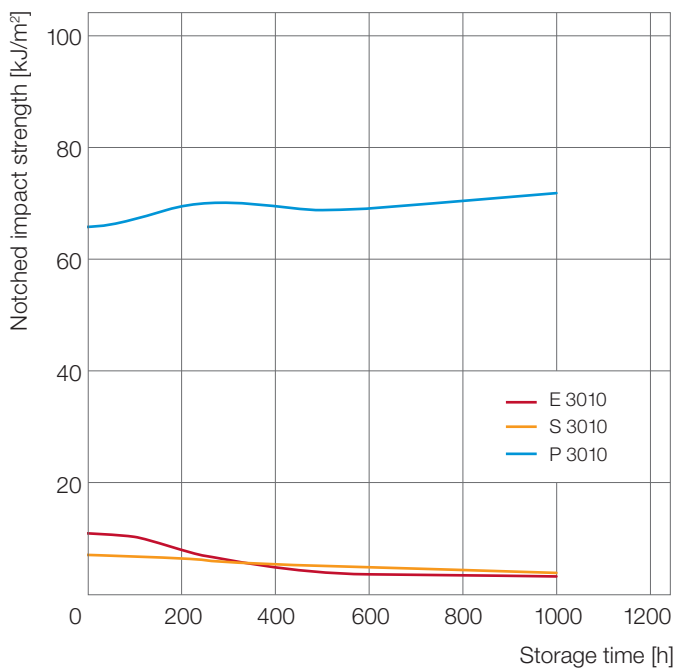

Fig. 35: Stability of Ultrason® in the presence of FAM B at 23°C

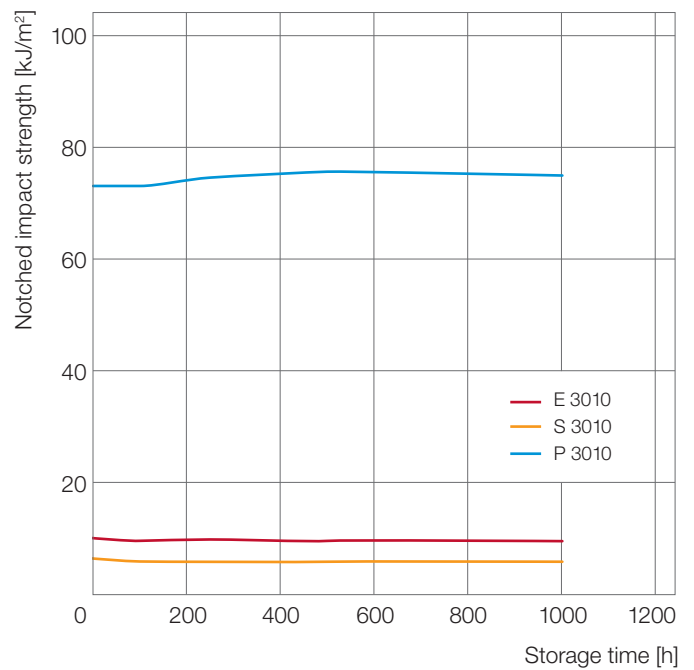

Fig. 37: Stability of Ultrason® in the presence of glycol (50% in water) at 23°C

Electrical properties

For applications in electrical engineering and electronics, Ultrason® has an extremely favorable combination of properties: good insulation properties (high volume resistance and surface resistance), high breakdown rating, favorable dielectric values, outstanding mechanical properties even at elevated temperatures, high long-term service temperature, and very good fire behavior.

The creep resistance – as with most aromatic plastics – is relatively low. The electrical properties are only slightly affected by moisture absorption. The electrical test values are compiled in the Ultrason® product range.

The dielectric constant of Ultrason® is essentially stable over a broad frequency range, and temperature range from -50°C up to the glass transition temperature. The dielectric dissipation factor shows only a marginal dependence on frequency and temperature, and is remarkably low for a polar plastic (Fig. 38).

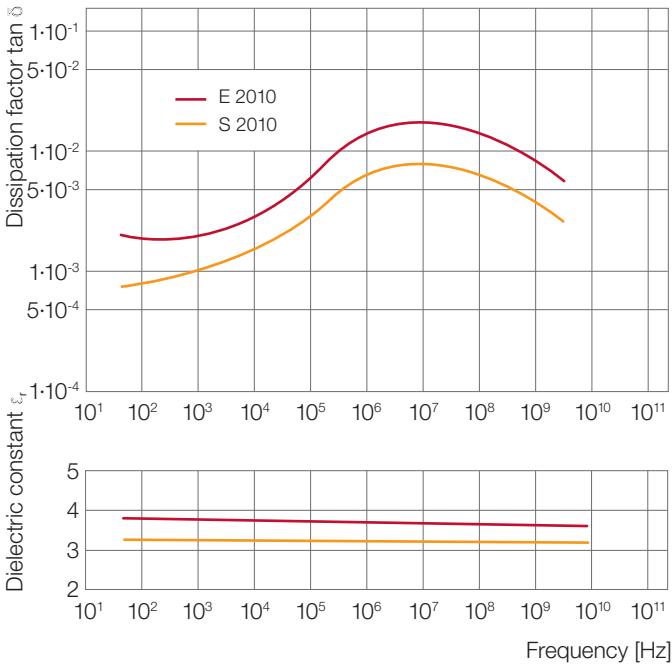

Fig. 38: Dielectric dissipation factor $\tan \delta$ and dielectric constant ϵ_r of Ultrason® S 2010 and E 2010 as a function of frequency (under standard climatic conditions)

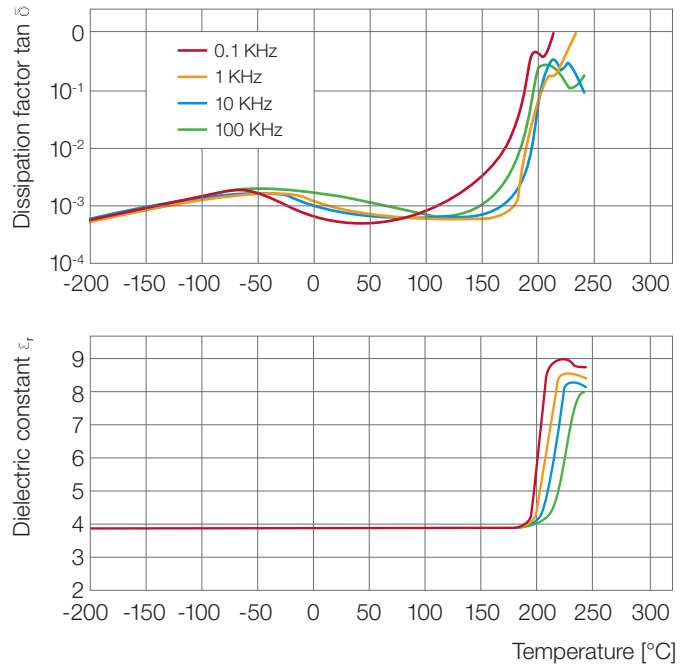

Fig. 39: Dielectric dissipation factor $\tan \delta$ and dielectric constant ϵ_r of Ultrason® S 2010 as a function of temperature

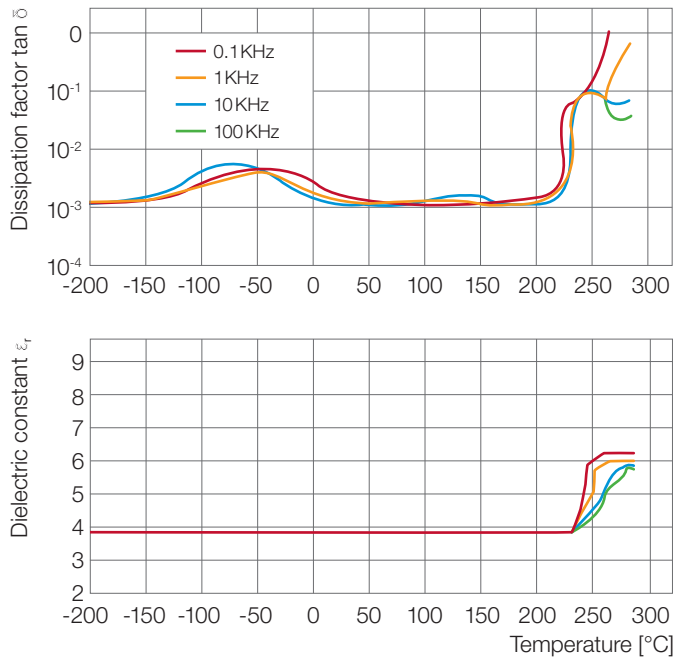

Fig. 40: Dielectric dissipation factor $\tan \delta$ and dielectric constant ϵ_r of Ultrason® E 2010 as a function of temperature

Fire behavior

General information

Thermal degradation of Ultrason® begins at temperatures above 400 °C. The extent to which ignitable concentrations of combustible gases are formed depends on the heating and ventilation conditions. Under the test conditions specified in DIN 54836, the ignition temperatures were determined with an external flame (EMF) to be 475 °C for Ultrason® S, 510 °C for Ultrason® E, and 575 °C for Ultrason® P.

The main substances formed in the combustion of Ultrason® are carbon dioxide, water, and sulfur dioxide. Depending on the availability of oxygen, carbon monoxide and uncombusted primary decomposition products such as phenols and aromatic sulfonic acids are formed. Products made of Ultrason® are characterized by low flammability, low flame propagation, and especially low smoke emission. Fires extinguish after the ignition source is removed, even without any additional flame retardants (Table 1).

Tests

Electrical engineering

Various material tests are performed to assess the fire behavior of electrically insulating materials. The classification of insulating materials testing according to IEC 707/ DIN VDE 0304, Part 3 (determination of flammability on exposure to ignition sources) was adopted. It has three test protocols from which a selection can be made:

Method BH: Glow rod; horizontal specimen orientation

Method FH: Bunsen burner; horizontal specimen orientation

Method FV: Bunsen burner; vertical specimen orientation

An additional test on rod-shaped specimens is the classification according to the UL 94 standard, Test for Flammability of Plastic Materials for Parts in Devices and Appliances of the Underwriters Laboratories Inc./USA. The test results for Ultrason® are summarized in Table 2.

Ultrason® E	26,000 kJ/kg	7.2 kWh/kg
Ultrason® S	31,000 kJ/kg	8.6 kWh/kg
Ultrason® P	29,000 kJ/kg	8.1 kWh/kg

Table 1: Calorific value for Ultrason® (estimated according to Dulong)

	IEC 707/DIN VDE 0304 (Part 3)			UL 94
	BH	FH	FV	B .../mm
Ultrason® S unreinforced	BH 2-14 mm	FH 2-14 mm	FV 2	V-2/3.2
Ultrason® S glass-fiber reinforced	BH 2-13 mm	FH 2-14 mm	FV 0	V-0/3.2
Ultrason® E unreinforced	BH 2-13 mm	FH 2-14 mm	FV 0	V-0/1.6
Ultrason® E glass-fiber reinforced	BH 2-13 mm	FH 2-14 mm	FV 0	V-0/1.6
Ultrason® P unreinforced				V-0/1.6*

* Results of in-house tests

Table 2: Fire behavior of Ultrason® according to IEC 707/DIN VDE 0304 (Part 3) and UL 94

Unreinforced Ultrason® S is classified as UL 94 V-2 at a thickness of 3.2 mm. Glass-fiber reinforced Ultrason® S with the same thickness is classified as UL 94 V-0. Ultrason® E is classified as UL 94 V-0 at a thickness of 1.6 mm. According to in-house tests, Ultrason® P qualifies for the same classification.

Transportation

Transportation, automobiles, rail vehicles, and aircraft all have different requirements. By virtue of their favorable fire behavior, Ultrason® E and P are especially suitable for automobile and rail vehicle parts. For example, Ultrason® E 2010 at a thickness of 2.2 mm is rated as follows under regulation DV 899/35 of the German Federal Railway: category B 3 flammability (extremely fire- and flame-resistant; generally burns extremely slow on its own or does not continue to burn; burns or chars at a very low rate only if additional heat is applied); category Q 3 fume emission (moderate fume and soot emission); category T 3 burning drop formation (material is significantly deformed and softens in places, or elongated threads are formed instead of drops).

Test panels made of Ultrason® P meet the strict requirements of the aircraft industry, e.g., as described in the OSU test (FAR 25, App. F, Part IV & AITM 2.0006).

Civil engineering

The standard for testing building materials in Germany is DIN 4102, Part 1 "Fire behavior of building materials and building components." Unreinforced and glass-fiber reinforced Ultrason® S panels are categorized as class B2 building materials (normal flammability) and are rated as "Do not form burning droplets." Ultrason® E 2010 at a thickness of 2.2 mm complies with the requirements for the DIN 4102 as class B1 building material (low flammability).



Resistance to chemicals

While evaluating the durability of components made of Ultrason® against chemicals, the temperature of the medium and particularly the internal and external stresses that act on the molding must be considered. Owing to its amorphous morphology, Ultrason® is susceptible to stress cracking in the presence of certain organic solvents. As the molecular weight of Ultrason® increases, the resistance to chemicals improves, and the likelihood of stress cracking decreases. Glass-fiber reinforced products are considerably more resistant to chemicals and less susceptible to stress cracking than unreinforced products. The susceptibility to stress cracking can be significantly improved by annealing Ultrason® for several hours.

Even at elevated temperatures, Ultrason® is resistant to water, aqueous solutions, e.g., seawater, aqueous mineral acids, e.g., concentrated hydrochloric acid, organic acids, e.g., glacial acetic acid, alkalis, aliphatic hydrocarbons,

e.g., gasoline and kerosine, petroleum, alcohols, amines, most cleaning and sterilizing agents, oils, and fats, e.g., engine and transmission oils. Moreover, Ultrason® E is stable to oxidizing agents such as hydrogen peroxide or fluorine. Components made of Ultrason® E also withstand short-term exposure to aromatic solvents, e.g., benzene, xylene, or toluene. The same applies to esters, ketones, and certain halogenated hydrocarbons, which can, however, start stress cracking and have a partly dissolving effect in prolonged contact. Resistance to fuels and lubricants has already been discussed (Fig. 32ff.). Ultrason® P is very stable in the presence of hot water or superheated steam, conditions during sterilization, for example.

Details on the resistance of Ultrason® to chemicals are given in the technical information “Resistance of Ultrason® to chemicals.”



Filter membrane

Resistance to weathering

As is the case with most other aromatic polymers, uncolored Ultrason® moldings yellow and become brittle quite rapidly if they are exposed to atmospheric conditions. Moldings reinforced with glass fiber or colored with carbon black are significantly more resistant to UV light. Effective protection is achieved through surface coating or metallizing.

Resistance to high-energy radiation

Ultrason® is very resistant to beta, gamma, and X-rays over the entire range of working temperatures. Only at high radiation doses (over 2 MGy) do Ultrason® E products suffer a noticeable decline in yield point and a significant decrease in elongation at break. There is very little outgassing. The transmissibility for gamma and X-rays is very high.

Ultrason® is also characterized by a very low microwave absorption rate.



Headlight bezel

Water absorption and dimensional stability

Ultrason® moldings absorb a certain amount of moisture when they are immersed in water or exposed to air. The amount absorbed depends on the humidity, duration of exposure, temperature, wall thickness, and the actual Ultrason® product. The time course of water absorption follows the law of diffusion. Fig. 41 shows the time course of water absorption of Ultrason® under various experimental conditions.

Moisture absorption affects the mechanical properties. Especially with unfilled Ultrason® E, moisture absorption increases primarily the impact strength and slightly the elongation at break. Strength and tensile modulus of elasticity are only affected a little. The dimensional change due to water absorption is limited for all Ultrason® products (Table 3).

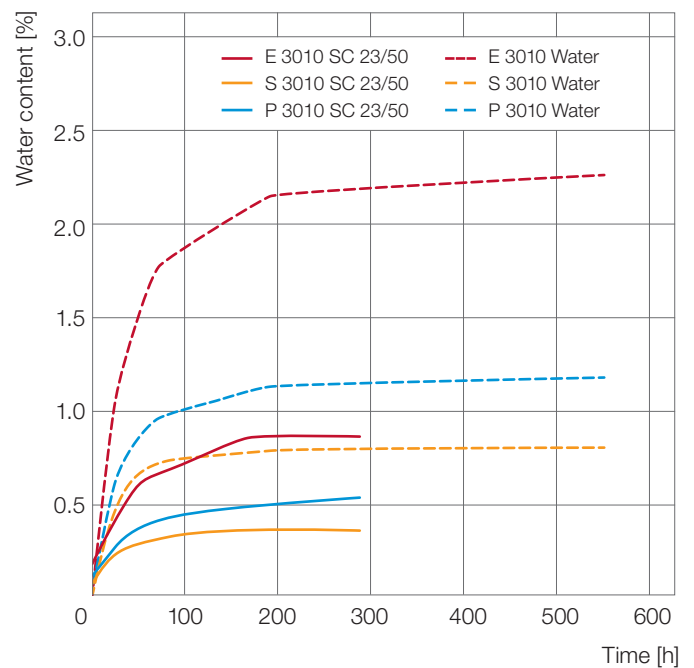

Fig. 41: Water absorption of Ultrason® as a function of storage time (under standard climatic conditions and immersed), 2 mm specimen thickness

	Water absorption [%]	Change in cross section [%]	Change in length [%]
Ultrason® S	0.8	+0.1	+0.1
Ultrason® S G6	0.6	+0.1	+0.1
Ultrason® E	2.2	+0.3	+0.3
Ultrason® E G6	1.6	+0.3	+0.1
Ultrason® P	1.2	+0.1	+0.1

Table 3: Water absorption and dimensional change in injection-molded tensile bars after immersion in water at 23°C up to saturation

The Processing of Ultrason®

Ultrason® can be processed with all the methods known for thermoplastics. The most important of these are injection molding and extrusion.

General information

Pretreatment

Ultrason® granules can absorb moisture within a very short time. Even very low amounts of moisture ($\geq 0.05\%$) are enough to cause optical damage to the moldings during the processing of Ultrason®. Ultrason® must always be dried before processing, for at least three to four hours in a vacuum drying cabinet or a dry-air dryer at 130°C to 150°C. Circulating air dryers are not suitable for Ultrason®. For optimum results, the moisture content should be below 0.02%.

Startup and shutdown

The processing equipment is started up according to the usual procedure for thermoplastics: The heaters are initially set to reach average melt and mold surface temperatures for the corresponding Ultrason® product, according to Table 4; the processing temperatures are then adjusted, if necessary. The barrel heaters must be switched off in case of longer interruptions; if the interruptions are shorter, the heaters can be turned down by around 100°C. The injection molding machine screws should be set in the frontmost position (melt cushion 0mm). When the machine is restarted, any product that remained in the barrel should be pumped out.

Compatibility of Ultrason® products with one another and with other thermoplastics

If Ultrason® is mixed with other polymers during handling (e.g., in the dryer, in feed lines) or due to small residues in the injection unit, the moldings will be cloudy. This is also true when Ultrason® polymers get mixed with each other. Mixing of Ultrason® with even small amounts of PE, PP, PS, or PPE, for instance, results in noticeable interferences, e.g., as lamination and reduced impact strength. Some thermoplastics will be at risk to thermally decompose due to the high temperatures required for processing Ultrason®.

Colors

Ultrason® is supplied mainly as uncolored or black. However, there is also the possibility to produce any color desired through specifically manufactured master batches (self-coloration). It might be necessary to equip the processing machines with special screws and/or mixing units to carry out self-coloration. The color batches must be based on the corresponding polymer.

Product	Melt temperature range [°C]	Mold temperature range [°C]
Ultrason® E unreinforced	340 - 390	140 - 180
Ultrason® E reinforced	350 - 390	150 - 190
Ultrason® S unreinforced	330 - 390	120 - 160
Ultrason® S reinforced	350 - 390	130 - 180
Ultrason® P unreinforced	350 - 390	140 - 180

Table 4: Standard values for the melt and mold temperatures during injection molding

Reprocessing and recycling

In connection with Ultrason®, recycled material consisting of sprues, rejects, and the like can be recycled in limited amounts (up to about 20%), provided it has not been contaminated and the material was not thermally degraded during previous processing. Ultrason® regrind is particularly moisture-absorbent. Even if the regrind was stored under dry conditions, it is absolutely necessary to dry it shortly before processing. The addition of regrind to virgin granules can alter the feed, flow, and demolding characteristics, as well as the mechanical properties, and in particular the impact strength. Therefore, virgin material should be exclusively used for high-quality engineering components.

Injection molding

Ultrason® can be processed on any type of commercially available injection molding machines, provided that the plasticizing unit has been configured appropriately and the injection unit and mold have a fitting temperature control system.

If there are any doubts regarding the thermal stability of machine components (e. g., barrel, barrel head, bolted connections, etc.), the machine manufacturer must be consulted.

Plasticizing unit

Three-section screws

The common three-section screws used for other engineering thermoplastics are also suitable for the injection molding of Ultrason®. An effective screw length of 18-22 D and a pitch of 0.8-1.0 D give particularly good results in the processing of Ultrason®. Recommended flight depths for various screw diameters are listed in Fig. 42.

Screws with shallow flights take on less material than those with deep flights, and thus the melt has a shorter residence time in the barrel. The granules are consequently melted more gently and are not as exposed to thermal loads. This is advantageous for obtaining moldings of superior quality.

Screw tips and non-return valves

The design of the screw tip and the non-return valve is crucial to the interference-free melt flow in the plasticizing unit.

Machine nozzles

Both open nozzles and needle shut-off nozzles can be used. Open nozzles are often preferred to valve nozzles because of their streamlined design; they particularly allow for a easier change of colored grades. On the other hand, melt that has solidified in the nozzle aperture can be removed more easily and completely from shut-off nozzles than from open nozzles.

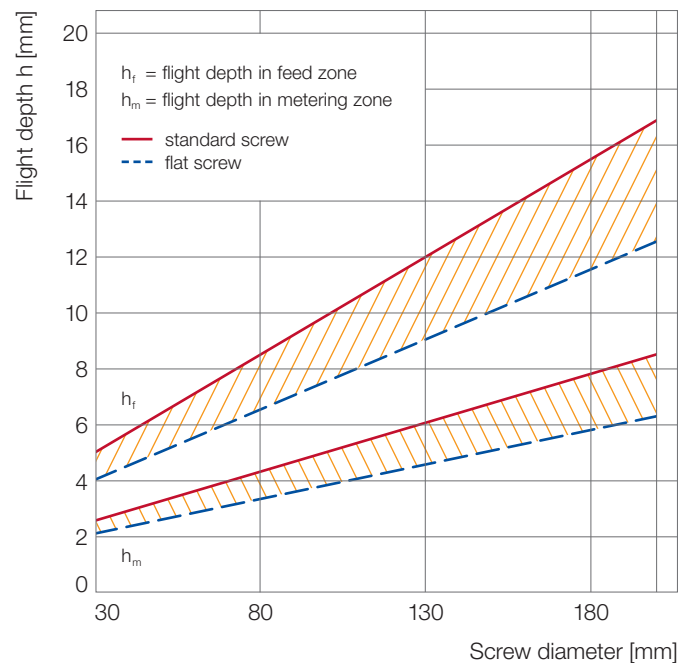

Fig. 42: Flight depths of three-section screws for injection molding machines

Protection against wear

Common nitrided or borided screws and barrels can only be used conditionally in the processing of Ultrason®. If their thermal stability and expected durability are in doubt, the manufacturer should be consulted. As is the case in processing most glass-fiber reinforced thermoplastics wear-protected injection units should be used, e.g., bimetal barrels and armored screws, screw tips, and non-return valves.

Heaters, controllers, and thermal elements

Standard heater bands are generally sufficient for the processing of Ultrason®. Ceramic heater bands usually have a longer lifetime, however, and their use is therefore advised.

Injection mold

Mold design

The high mold and melt temperatures are factors that must be considered in selecting the tool steel for the mold. Depending on the operation temperature, possible structural changes in the steel and the associated deterioration in its properties and/or dimensional changes have to be taken into account. The temperature at which the steel is tempered should be at least 50K higher than the operating temperature in the mold. Good results have been obtained with high-alloy hot-forming steels, e.g., 1.2343 and 1.2344.

Standard guidelines for mold design according to VDI 2006 also apply to Ultrason® products.

Draft angles and ejectors

Important factors in eliminating demolding problems are draft angles and transition radii that are adequately dimensioned. As a rule, the draft angle on injection molds for Ultrason® is one to two degrees. An important design aspect is that the surface area of the ejector pins or stripper plates is as large as possible to ensure that the moldings are not pierced or deformed during demolding.

Gate types

All conventional gate types can generally be used, including hot runner systems. Owing to the high processing temperatures required for Ultrason®, self-insulating hot runner and antechamber systems can run the risk of melt solidification. Long residence times can give rise to thermal degradation of the product. The gates must be of sufficient size; otherwise, with small cross sections, the melt temperature will often be unnecessarily set too high due to the high injection pressure. As a result, burn marks can appear on the surfaces of the moldings. Premature solidification of the melt in the gates can be responsible for voids and sink marks on the component, because the volume contraction of the melt during the holding pressure phase cannot be compensated.

Inserts

Overmolding metal parts is possible without any problems. To avoid excessive residual stresses, larger inserts should be preheated to 150°C, or at least to the mold temperature.

Mold temperature control unit

The quality of moldings depends very much on the temperature pattern within the mold. Exact mold temperature control is possible only with a well-designed system of temperature control channels within the mold in combination with sufficiently dimensioned temperature control units. If a rapid coupling system is used, the suitability of the system should be checked to ensure that it functions satisfactorily with respect to the pressure and temperature loads within the mold. The mold temperatures required for Ultrason® can be set with control devices that use oil as the temperature control medium. With special water temperature control devices, temperatures of up to 200°C can be regulated. If the water temperature exceeds 100°C, the overall temperature control system has to be pressure-tight in addition to using adequate temperature control devices (system pressure of about 20 bar at 200°C). Electrically heated molds are an option in certain cases.

Injection molding processing

Melt temperatures

The melt temperature ranges recommended for various Ultrason® products are listed in Table 4. Higher melt temperatures should be avoided due to the risk of thermal degradation of the melt.

Mold temperatures

The mold surface temperature affects the quality of the finish, shrinkage, warpage, dimensional tolerances, and the level of internal stress in the molding.

Ultrason® is usually processed at mold temperatures of 120 -160 °C. The only products that need higher temperatures to achieve an optimum molding finish are the reinforced or filled Ultrason® types. Table 4 gives an overview of the required mold surface temperatures; heat losses can be reduced by adding insulation between the mold and the platen. A good temperature control channel system together with correct mold temperature settings is essential for high-quality injection moldings.

Barrel temperatures

Gentle melting conditions during long melt residence times in the barrel can be achieved, if the temperature settings on the barrel heater bands are set to increase in the direction from the feed hopper to the nozzle. If the

screw should squeak during feeding, this can possibly be remedied by a horizontal temperature profile. At least one heater band – with a heat output of 450 -500W – is required for the nozzle, since significant thermal losses occur due to the radiative and thermal conduction to the injection mold, potentially leading to the solidification of the melt in the nozzle.

Residence time in the barrel

The residence time of the plastic in the plasticizing barrel has a considerable effect on the quality of the moldings. Especially when operating in the higher melt temperature range, a short cycle time and thus short residence time should be ensured.

Flow characteristics

The flow characteristics can be determined, for example, by using a spiral mold on a commercially available injection molding machine. With a given injection pressure of 1,000bar, the path covered by the melt in this mold can thus be taken as a measure of the flowability. However, the possible flow path is affected not only by the flow characteristics of the plastic, but also by the processing conditions, the geometry of the molding, and that of the gating system. So the values in Table 5 are only conditionally transferable to real components.

Ultrason®	T _M [°C]	T _w [°C]	Spiral length [mm]			
			Thickness 1 mm	Thickness 1.5 mm	Thickness 2 mm	Thickness 2.5 mm
S 2010	370	160	90	195	280	380
S 3010	370	160	73	165	230	315
	390	160	95	180	250	370
S 6010	370	160	68	120	155	230
	390	160	77	150	180	270
S 2010 G6	370	160	75	105	150	300
E 1010	370	160	125	200	290	420
	390	160	131	260	375	520
E 2010	370	160	77	160	230	320
	390	160	97	195	290	410
E 3010	370	160	70	110	165	210
	390	160	73	130	200	270
E 2010 G6	370	180	58	135	160	230
	390	180	72	145	210	300
P 3010	370	160	55	95	125	165
	390	160	67	120	160	270

Table 5: Flow path lengths at various spiral flow thicknesses

Holding pressure

The holding pressure and the holding pressure time should compensate as much as possible the volume contraction that occurs during solidification and further cooling. To prevent an excessively high holding pressure from overloading the gating zone, the adjustment of a holding pressure profile is often advisable.

Warping

Ultrason® moldings hardly tend to warp; however, care must be taken to ensure a uniform temperature distribution in the mold. The tendency to warp is somewhat higher with glass-fiber reinforced products due to the anisotropic shrinkage behavior.

Demolding

The draft angles on injection molds for Ultrason® should generally be one to two degrees. The transition radii design should be as large as possible. All sharp angles and edges should be rounded with a minimum radius of 0.4 mm. Since the demolding temperatures are relatively high, the equipment for handling the moldings, e. g., grippers, suction devices, and conveyor belts, must be heat-resistant.

Shrinkage and postshrinkage

The procedure for measuring shrinkage in processing is set out in ISO 294. In order to estimate shrinkage behavior, the shrinkage values for Ultrason® according to ISO 294 are summarized in Fig. 43. These shrinkage values show that—as with most thermoplastics—differences between linear and transverse shrinkage occur mainly in glass-fiber reinforced products. Post-shrinkage in amorphous Ultrason® is negligibly low.

Additional information on injection molding can be found in the brochure “Ultrason®–Injection molding.”

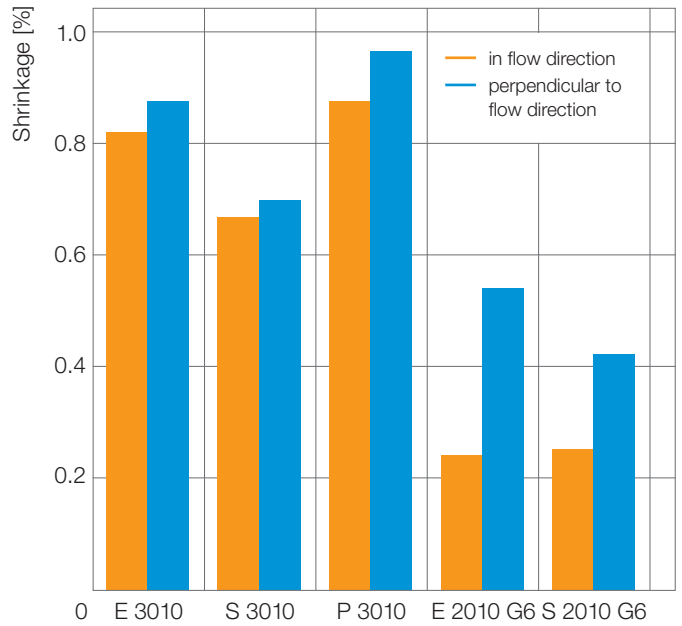

Fig. 43: Shrinkage values for various Ultrason® products parallel and transverse to the flow direction

Extrusion

Ultrason® is suitable for the extrusion of semifinished products such as panels, chill-roll films, tubes, and profiles, as well as for the manufacture of blow-molded, hollow parts.

The products with a higher viscosity should be preferred, i. e., Ultrason® E 3010, Ultrason® S 3010, and Ultrason® P 3010. Suitable extruders are those with three-section screws and corresponding cut vented screws. A screw length L of 30 D has proved useful in vented extruders. For other screws, a length of 25 D and a constant pitch of 1D is common. The compression ratio should be up to 2.3:1.

Breaker plates and screens are required to compensate for different values of mold resistance and for pressure generation. Excessively high pressures due to the use of very fine screens should be avoided. To avoid increasing melt temperatures resulting from frictional heating, the flight depth of the screw should be larger in extruders with grooved and heat-separated feed zones than in those used for the processing of high-molecular PE-HD.

Shear and mixing elements should not be used to avoid an increase in melt temperature through frictional heating. The grooved feed zone should be heated to 220°C to 250°C.

Extruders and parts that come into contact with the melt should be designed to withstand melt temperatures of up to 390°C. The temperature in the feed section should be comparatively low (about 160-200°C) to prevent bridging and to ensure that the material is conveyed uniformly. Generally, temperatures from 280°C to 340°C are required in the compression zone and the metering zone. All parts that come into contact with the melt must be streamlined so as to avoid the presence of dead spots. If no vented screw is available during processing, the granules must be intensively predried and kept perfectly dry during processing.

Only vacuum dryers or dry-air dryers should be used for drying (see "Pretreatment").

Manufacture of tubes, profiles and panels

Tubes and profiles made of Ultrason® are extruded according to common vacuum or vacuum water bath calibration procedures. The 3010 products with higher viscosities are particularly suitable for this purpose, and even permit the manufacture of large-size tubes and profiles. With these products, tubes with outer diameters ranging from only a few millimeters to about 200mm can be extruded. Corresponding wall thicknesses from a few tenths of a millimeter to about 10mm can be produced. Depending on the extrusion process used and the dimensions of the tube, internal stresses can occur, which can be minimized by the selection of appropriate processing conditions and post-treatment, if necessary. A fundamental rule is that to obtain extrudates with a low level of internal stress, the melt must be cooled as slowly as possible. This can be achieved by extruding with:

- the lowest possible melt temperature
- the smallest possible difference between the melt temperature and the temperatures of the downstream equipment (possibly by raising the temperature of the water bath or by dry calibration)

	Ultrason® E 3010
Tube dimensions (outer diameter x wall thickness)	6.2 x 1 mm
Extruder	ø 45 mm, 25 D
Screw – Length of sections: $L_f/L_c/L_m$ – Depth of flights: h_f/h_m	8/6/11D 7.5/3 mm
Temperature settings – Extruder (from feed section to screw tip) – Adapter – Pipe die head – Die	180/340/... 300°C 300°C 300°C 300°C
Die diameter	ø 16.8 mm
Mandrel diameter	ø 12.2 mm
Die gap	2.3 mm
Vacuum/water bath	40-50°C
Sizing plate diameter	ø 6.3 mm
Screw speed	20 min ⁻¹
Melt temperature	320°C
Extrusion pressure	100 bar
Rate of haul-off	11.3 m/min
Output	13.9 kg/h

D = Screw diameter L_c = Length of compression section
 h_f = Depth of flights in feed section L_f = Length of feed section
 h_m = Depth of flights in metering section L_m = Length of metering section

Table 6: Example of extrusion of Ultrason® tubes

Thick-walled hollow and solid sections, e. g., round rods, flat rods, and hollow rods, are mainly extruded through a cooled die. The equipment available for other thermoplastics is basically also suitable for Ultrason®, provided it can be heated to adequately high temperatures. Regarding the temperature-controlled part of the cooled die, the heating generally has to be converted from water to oil to be able to achieve the temperatures of 170°C to 180°C (for Ultrason® S) or 200°C to 210°C (for Ultrason® E and P), which are required for slow cooling.

With the 3010 products thin-walled and thick-walled components can be manufactured. Due to the necessarily high residence time of the melt for the extrusion of semifinished products, the melt temperature should be kept in the range of 280°C to 320°C. Volume shrinkage can be compensated by high pressure and a rate of output that meets the requirements of the corresponding wall thickness.

Stresses that arise due to the time difference between the melt solidification and the cooling to room temperature can be relieved through subsequent thermal treatment (annealing). The temperature is crucial for the effectiveness of the annealing process. It should be 215°C for Ultrason® E, 180°C for Ultrason® S, and 205°C for Ultrason® P. The annealing time should be adjusted to the corresponding thickness of the semifinished product (see “Annealing”).

Rod diameter	60 mm
Extruder	ø 45 mm, 25 D
Screw	
– Length of sections: $L_f/L_c/L_m$	8/6/11 D
– Depth of flights: h_f/h_m	6.5/3 mm
Temperature settings	
– Extruder	180/280/... 320°C
– Adapter	320°C
– Heated part of mold	320°C
– Temperature-controlled part of mold	170°C
Screw speed	8 min ⁻¹
Rate of haul-off	20 mm/min
Output	4.7 kg/h

D = Screw diameter L_c = Length of compression section
 h_f = Depth of flights in feed section L_f = Length of feed section
 h_m = Depth of flights in metering section L_m = Length of metering section

Table 7: Example for extrusion of Ultrason® E 3010 in circular rods

Manufacture of Panels

Panels are manufactured with commercially available equipment that can be heated to the necessary temperature level, equipped with slit dies, three-roll polishing stack, and subsequent take-off. The lips of the slit die should extend as closely as possible to the roll gap. The temperatures of the rolls are adjusted to the panel thickness and vary between 160°C at the lower roll (at the melt feed in the lower roll gap) and the corresponding glass transition temperature at the upper roll.

	Ultrason® S 2010	Ultrason® E 3010
Cross-sectional area of panels	950 x 2 mm	765 x 4 mm
Extruder	ø 90 mm, 30 D	ø 90 mm, 30 D
Screw		
– Length of sections	$L_{f/c/m} = 9/1.5/6 D$	$L_{f/c/m} = 12/8/10 D$
– shearing section	0.5 D / 0.75 mm gap venting section 4.5 D	
– Depth of flights	$L_{f/c1/m1} = 1/5.5/2 D$ $h_{f/m} = 10.8/4 mm$ $h_{f1/m1} = 16.8/5.6 mm$	$h_{f/m} = 14/6 mm$
Die width	1,100 mm	800 mm
Temperature settings		
– Barrel	240/330/ 340/300°C	240/320/ 340/300°C
– Adapter	300°C	300°C
– Die	310°C	310°C
Three-roll polishing stack	300 mm roll diameter	300 mm roll diameter
Temperature:		
upper roll	225°C	210°C
center roll	200°C	200°C
lower roll	170°C	200°C
Infra-red heaters installed around	center and delivery rolls	center and delivery rolls
Screw speed	35 min ⁻¹	20 min ⁻¹
Melt temperature	367°C	360°C
Rate of haul-off	0.78 m/min	0.52 m/min
Output	120 kg/h	134 kg/h

D = Screw diameter L_c = Length of compression section
 h_f = Depth of flights in feed section L_f = Length of feed section
 h_m = Depth of flights in metering section L_m = Length of metering section

In column headed Ultrason® E 2010 (vented screw), the index ... 1 has been appended to the corresponding dimension in the sections of the screw downstream from the vented section.

Table 8: Example for the extrusion of Ultrason® S 2010 and Ultrason® E 3010 panels

In most cases infrared radiators have to be installed to get adequate flatness. It is advantageous to position several radiators at the central and upper rolls (delivery rolls) as well as at the beginning of the air-cooling section.

Output and take-off speed are to be aligned with one another so that a small bead that evenly spans the roll width forms in front of the roll gap. The tolerance and surface smoothness are favorably influenced in this way. The achievable panel thickness depends on the diameter of the polishing stack. 300 mm rolls are sufficient for a thickness of 2-3 mm, whereas rolls with a larger diameter are necessary for greater thicknesses.

Manufacture of Ultrason® foam (Ultratect®)

Ultrason® can be processed into foams using a method patented by BASF, the Ultratect® technology. Both a discontinuous block foaming process as well as a continuous extrusion foaming process can be realized. In the case of extrusion foaming, endless sheets of adjustable thicknesses are produced, which can then be trimmed to the required size. The foaming is made possible by the use of physical blowing agents. Typical densities are in the range of 40 to 120 g/l, depending on the type of application. Ultratect® distinguishes itself from many other thermoplastic foams by its typical Ultrason® properties, such as resistance to temperature and chemicals as well as its inherent flame retardance.

Blow molding

All Ultrason® products are suitable for blow molding. The use of a storage head can be necessary. The melt temperature range recommended for the extrusion of the premolding is 280 °C to 330 °C. Since the heat radiated at these high temperatures to the flange, storage head, and parison die increases sharply, it is recommended to insulate these.

Good surface quality is achieved with a mold surface temperature of 80 °C to 100 °C. Undercuts should be avoided on blow molds, e. g., on the thread run-out or from concave bottle bottoms.

Information on recycling parison waste is described in the section "Reprocessing and recycling".

Films for optical applications

Film extrusion is also suitable for the manufacture of films with particularly high requirements as to optical properties. For instance, high optical transparency, minimum residual stress, and excellent surface quality are required for films to be used in displays. These requirements can be fulfilled with appropriately designed extrusion equipment. Ultrason® E 2010 HC, which is optimized in respect of color, is commonly used for these applications. In order to minimize residual stress while achieving optimal surface quality, the temperatures of the tools, rolls, and melt should be in the upper range of processing temperatures. Typical film thicknesses are in the range of 100-500 µm (see the section "Optical properties").

Manufacture of films with slit die

Commercially available chill-roll equipment is suitable for the manufacture of chill-roll films, if it has sufficient heater capacity. It must be ensured that temperatures of about 350 °C can be set, particularly near the die lips, where the risk exists that the melt might solidify in the edge zones.

Width of film	310 mm
Film gauge	100 µm
Extruder diameter/length	ø 60 mm, 25 D
Screw	
– Length of sections: $L_f/L_c/L_m$	10/5/10 D
– Depth of flights: h_f/h_m	9/3 mm
Width of die	400 mm
Die gap	0.5 mm
Temperature settings	
– Barrel	300/300/320/320 °C
– Flange	300 °C
– Die	320 °C
– Chill rolls	210/200 °C
Screw speed	37 min ⁻¹
Melt temperature	370 °C
Rate of haul-off	12 m/min
Output	36 kg/h

D = Screw diameter
 h_f = Depth of flights in feed section
 h_m = Depth of flights in metering section
 L_c = Length of compression section
 L_f = Length of feed section
 L_m = Length of metering section

Table 9: Example for extrusion of Ultrason® E 2010 chill-roll film

Machining and postprocessing

It is important for all machining processes that the semifinished product or molding is firmly clamped and arranged on the support so that it cannot vibrate or yield. In addition, sufficient cooling of the semifinished products is necessary. The machining tools must be sharp at all times and have a cutting angle and rake suitable for thermoplastics.

Machining

Semifinished products made of Ultrason® are readily machined. The cutting force is low compared to metal machining. The feed rate is 0.1 to 0.5 mm/U, depending on the desired surface roughness. The following machining methods may be considered: lathing, milling, sawing, drilling (spiral drilling), tapping (threads with large pitch and trapezoidal edges), punching, and reaming. Water is well-suited for the cooling of semifinished product. Emulsions can lead to stress cracking in some cases.

Blanking

Thin Ultrason® panels can be blanked with commercially available guillotine shears. The cut must be smooth and uninterrupted.

Sawing

The best method for cutting Ultrason® semifinished stock is by sawing. In the case of band saws, the saw band speed should be 1,000 to 1,500 m/min, and the saw band should have six to ten teeth per inch. Suitable circular saws have circumferential speeds of 3,000 to 4,000 m/min and saw blades with five to six teeth per inch. Contours in moldings can be cut out by compass saw, featuring saw blades with 18 to 22 teeth per inch.

Assembly methods

Unbreakable connections between Ultrason® moldings can be made by means of various welding techniques, in particular. Adhesives are used for firm bonds between Ultrason® and other materials. Other means of forging unbreakable connections are riveting and beading.

Welding

The conventional welding techniques adopted for thermoplastics are suitable for the various Ultrason® products (with the exception of the high-frequency method). The high-frequency method—as is the case with other thermoplastics with low dielectric dissipation factors—is unsuitable for welding Ultrason®. If the Ultrason® moldings have absorbed moisture, it is absolutely essential to dry them before welding, in order to avoid foaming in the welding zone during the melting phase.

The welding technique of choice depends on the moldings and on their stress pattern. It is recommended that the most suitable technique be selected and the welding parameters be optimized by preliminary tests.

Ultrasonic welding is recommended primarily for smaller components. Welding times of less than two seconds make for extremely short cycle times. The components must show weld seam geometries that conform to the requirements for ultrasonic welding. The welding parameters to be set are dependent on the component and the material.

Optimization of the welding parameters should be carried out in each case by systematic variation. The attainable welding parameters, i. e., the ratio of the strength of the weld to that of the material, depends on the component design and material.

Heated tool welding is primarily useful for joining large parts, e. g., pipes and panels. Ultrason® needs high heated tool temperatures, for which conventional nonstick layers are unsuitable. In heat contact methods, the heated tool must be continuously cleaned to remove adhering residues. Alternatively, contactless heating by the heated tool (or IR radiation) is possible.

Vibration welding is appropriate for medium-large and large moldings with a joining surface that is flat in at least one direction. The weld must be prepared in such a way that the parts have enough room to move in the direction of vibration. Lower joining pressures in this method tend to lead to higher weld strengths.

Spin welding is suitable for rotationally symmetrical moldings. The achievable weld strengths are similar to those achieved in vibration welding.

Laser welding (counter or quasi-simultaneous method) is another option for joining together parts made of Ultrason®. It is required that one of the moldings to be welded must be transparent to the laser wavelength used while the other must be absorbent. Ultrason® can show very high transparency at wavelengths from 400nm.

Manual welding techniques are likewise possible for joining individual parts. In hot-gas welding, for example, the required air temperature is between 450°C and 500°C, and the diameter of the filler material should be determined by the wall thickness of the component.

Bonding with adhesives

Unbreakable bonds can be formed between Ultrason® and other materials—or even with itself—by means of various adhesive systems, e.g., epoxy resins, polyurethanes and phenolic resins. The best adhesive system is selected to meet the requirements of the component, e.g., resistance to heat, moisture, chemicals, etc. Since Ultrason®—as is the case with all amorphous thermoplastics—is susceptible to stress cracking in the presence of certain organic solvents, preliminary tests are essential in each case to determine the suitability of an adhesive system. To obtain reproducible adhesion, the joining surfaces should be appropriately pretreated every time (degreased, roughened).

Ultrason® can also be bonded with solvents such as dichloromethane. It is to be considered that solvents might cause stress cracking in parts that are subjected to mechanical stress. The viscosity of the solvent can be raised by adding 3% to 15% of Ultrason®. In any case, sufficient drying time must be allowed in order to ensure the complete removal of the solvent. The strength of adhesive bonds depends not only on the adhesive used, but also on the geometry of the bond seam. Good results are obtained with diagonal butt joints and tongue-and-groove geometries.

Detachable connections

Most suitable for detachable connections are screws and bolts and—with certain restrictions—snap-on connectors. Attention must be paid to the correct design of the threads. For bolted connections that must withstand heavy loads and ones that are frequently dismantled, threaded metal inserts placed in recesses that are provided in the Ultrason® part have proved useful. These inserts are press-fitted in a hot state, or—preferably—are secured with ultrasonic welding.

Coating, metallizing, and labeling

Two-component coating systems suitable for Ultrason® are available for coating moldings. Metallization of Ultrason® parts is possible with the use of vacuum coating techniques or the lamination of metal foil through thermal contact or ultrasonic welding. The possibility of wet-chemical metallization is limited with regard to filler-containing Ultrason® products. Ultrason® parts are laser-markable. Particularly sharp contrasts can be achieved with light colored and uncolored products.

Thermoforming

Ultrason® panels can be thermoformed on conventional thermoforming machines with vacuum or compressed air. The machine should be fitted with a heatable clamping frame and an adjustable twin-heating system that ensures a uniform temperature distribution over the entire surface and throughout the entire cross section of the semifinished product. The heaters must be designed to generate a forming temperature of 270°C to 280°C throughout the entire molding thickness.

In general, metal molds are used that are fitted with electric heating or oil circulation for temperature control. Wooden or cast-resin molds are unsuitable for thermoforming Ultrason®. The mold must be designed in a way that ventilation holes allow the air trapped between the mold and the heated semifinished product to escape rapidly. The ventilation holes should preferably be located at the points passed last by the semifinished products during the molding phase. As a rule, large roundings and inclined walls should be incorporated. Sharp edges must be avoided.

Female molds are primarily suitable for thermoforming of Ultrason® because the moldings are free to shrink from the mold walls. While using male molds there is the risk of cracking during the shrinkage.

If extruded semifinished products are not kept in protective packaging, they will absorb enough moisture after only 30 minutes at room temperature to form vapor bubbles on heating. Ultrason® parts that have absorbed moisture should therefore be dried prior to further processing. The drying time duration depends on the thickness of the panels and the temperature. Indicative values are given in Table 10.

Panel thickness [mm]	Drying time [h] at 140°C - 150°C
0.5	1
1.5	2
3	3
6	6

Table 10: Drying conditions for panels made of Ultrason®

For the thermoforming of Ultrason®, the clamping frame and mold are preheated to 150°C. The predried panels are likewise heated to 150°C, placed in the mold, and then immediately heated to 270°C to 280°C. Care must be taken during heating that no wrinkles form or sagging occurs with the panels, because that would lead to a non-uniform temperature distribution in the semifinished product, which in turn would result in non-uniform wall thicknesses in the final component. Since Ultrason® solidifies very rapidly, the overhead heater should remain over the semifinished product until Ultrason® has been completely demolded. Demolding takes place by suctioning the heated semifinished product from the mold. This process must be carried out very rapidly, significantly faster than is common for other thermoplastics.

Due to the rapid solidification of Ultrason®, the cooling time can be kept short and the part swiftly demolded. In this way, very short cycle times can be set.

Testing the stress level

If the mold is not designed correctly, or Ultrason® is processed improperly, the moldings can show a high degree of frozen-in stress. Welding of Ultrason® parts can likewise produce macroscopic internal stresses. These stresses negatively effect the mechanical properties, primarily the resistance to stress cracking through contact with media. A qualitative evaluation of the stress levels in unfilled Ultrason® products can be made via a stress crack test according to the following procedure:

- The molding is wetted with or immersed in the corresponding solvent mixture at room temperature for one minute (the solvent mixtures made from methyl ethyl ketone and isopropanol are given to the corresponding Ultrason® products in Table 11)
- Rinse molding with water
- Check molding for cracks

Determination of the stress level			
Methyl ethyl ketone/ isopropanol	Ultrason® product		
40/60	E 1010	S 2010	
		S 3010	
50/50	E 2010		
	E 3010		
80/20			P 3010

Table 11: Solvent mixtures for the evaluation of the stress level (depending on the Ultrason® product)

If the molding shows no cracks, it can be assumed that the molding has an acceptable stress level. This stress test is, however, only a guide to obtain optimum moldings. Suitability for a particular application cannot be derived from these results.

The listed solvents are readily flammable, irritating, and should not be released into wastewater. The appropriate precautions should be taken.

Annealing

Higher residual stresses in the molding can generally be reduced by subsequent annealing. In the process of annealing an amorphous thermoplastic (including Ultrason®) structural changes (changes in free volume) occur. This shows in minor changes in the mechanical and thermal properties. For example, stiffness increases but losses in toughness have to be accepted. Therefore, the part design and the processing parameters should generally be optimized so that an annealing process can be avoided.

If an annealing process is required nonetheless, this should take place as described in Fig. 44. The annealing time depends on the wall thickness of the molding.

Since Ultrason® components that are no longer freshly molded have moisture to some degree, depending on the environmental conditions, the annealing process must include a drying phase, which is dependent on the wall thickness of the component. Values for the drying phase can be found in Table 6. Based on these drying temperatures, the temperature should be increased at a heating rate of 10°C to 20°C per hour until the annealing temperature is reached. In the case of large-sized, thick-walled components, a rate of about 5°C per hour will be necessary to avoid crack formation during the heating phase.

The annealing process should be carried out for components

- made of Ultrason® E at about 200°C-215°C,
- made of Ultrason® S at about 160°C-180°C,
- made of Ultrason® P at about 190°C-210°C.

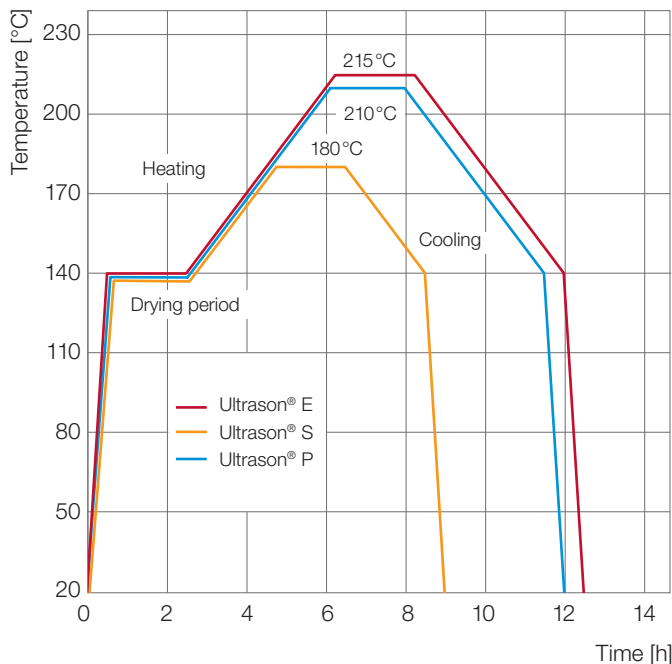

Fig. 44: Annealing of Ultrason®

The annealing time depends on the wall thickness of the molding. Standard values can be found in Table 12.

After annealing, the moldings are to be cooled at a cooling rate of about 10°C to 20°C per hour to approx. 140°C. More rapid cooling to room temperature can follow thereafter.

Wall thickness	Annealing time
2 mm	2-4 h
4 mm	3-6 h
8 mm	> 5 h

Table 12: Standard annealing time values for Ultrason® moldings in the corresponding temperature range

General Information

Safety notes

Safety precautions during processing

As high temperatures are involved in processing Ultrason[®], great care must be taken – even more so than for other thermoplastics – in handling the equipment, molds, moldings, and melt residues. The machine manufacturer must be consulted if any doubts exist regarding the thermal stability of the machinery and equipment. Based on our experience, no harmful emissions are released if normal precautions are observed and the upper temperature limit (maximum 390°C) is not exceeded while Ultrason[®] is being processed. As with all thermoplastic polymers, Ultrason[®] decomposes under excessive thermal stress, for example, if the melt temperature is too high, if the melt residence time in the plasticizing unit is too long, or if residues in the plasticizing unit are burned off, which produces gaseous decomposition products.

Care should generally be taken that the workplace has adequate ventilation and fume extraction, preferably by means of an exhaust hood over the barrel unit. Nevertheless, all accident prevention regulations must be strictly observed. Under no circumstances should the plasticizing unit be dismantled after a breakdown while still hot.

Any product that has decomposed during injection molding must be removed by purging it from the barrel and simultaneously reducing the barrel temperature. Unpleasant odors can be reduced through rapid cooling of the damaged material, e. g., in a water bath. Gas pressure might build up in the barrel if the decomposed material is not pumped out, especially when shut-off nozzles are used, which can lead to the pressure being released violently in the nozzle or hopper area. Deflagrations can thus be expected during the pumping-out process in such cases. The general dust threshold levels according to TLV guidelines must be observed in further processing.

Biological effects

No adverse effects on personnel working with Ultrason[®] have been reported during the appropriate processing of Ultrason[®] in a well-ventilated workplace. Ultrason[®] is not a hazardous substance as defined by the German Hazardous Substances Ordinance.

Food safety regulations

The compositions of many of the standard grades in the Ultrason[®] product range comply with the currently valid regulations in the USA and Europe concerning plastics in food contact applications. In addition, they meet the requirements of the recommendations by the BfR (Bundesinstitut für Risikobewertung = German Federal Institute for Risk Assessment, formerly BgV/BGA).

If you require detailed information regarding the status of specific Ultrason[®] products under foodstuff laws, please contact BASF directly (plastics.safety@basf.com). We would be happy to provide you with confirmation of conformity under current regulations.

Medical products

BASF has not developed any of its plastics products for use in medical devices as defined by the Medical Devices Act, including packaging for parenteral and ophthalmic products. Consequently, BASF has no experience concerning the suitability of Ultrason[®] in these applications. BASF cannot issue any product recommendations in the medical device applications area, therefore, which includes packaging for parenteral and ophthalmic products. BASF does not supply any plastics for the manufacture of implants, and expressly advises against the use of plastics supplied for other applications for this express purpose. BASF does not assume any liability in cases where BASF plastics are used in the manufacture of implants in contravention of regulations.

Should BASF customers decide from their own experience and from tests with Ultrason® that these plastics are suitable for the manufacture of products for medical applications involving short-term body contact, or short-term or temporary contact with fluids or tissues present in the body, or being introduced into the body, and/or for packaging of parenteral and ophthalmic products, then BASF is prepared to supply Ultrason® if an arrangement can be reached that takes into account the circumstances of the individual case.

Quality and environmental management

Quality and environmental management are an integral part of BASF's corporate policy. One key objective is to ensure customer satisfaction. A priority is to continuously improve our products and services with regard to quality, environmental friendliness, safety, and health.

The business unit Engineering Plastics Europe has a quality and environmental management system, which was approved by the German Society for Certification of Management Systems (DQS):

- Quality management system in accordance with ISO 9001 and ISO/TS 16949
- Environmental management system in accordance with ISO 14001.

The certification covers all services by the business unit in terms of the development, production, marketing, and distribution of engineering plastics. In-house audits and training programs for employees are conducted on a regular basis to ensure the reliable functionality and continuous development of the management systems.

Colors

Ultrason® is supplied mainly as uncolored or black. However, there is also the possibility to produce any color desired by specifically manufactured masterbatches (self-coloration).

Delivery and storage

Ultrason® is usually supplied as granules in bags, octabins and Big Bags. Depending on the settings, the bulk density can be 0.7-0.8g/cm³. Ultrason® can be stored indefinitely, provided the packaging is undamaged. Ultrason® granules contain moisture. They must therefore be dried before use (see "Pretreatment").

Ultrason® and the environment

Recycling

Unmixed, clean Ultrason® scrap can be reprocessed. Scrap from the manufacture of injection moldings, extrusion, or machining of semi-finished stock can be used as regrind and returned for processing. Regrind should be dedusted, especially when derived from products with glass fibers, carbon fibers or minerals. Unmixed moldings made of Ultrason® can likewise be processed into new parts after they have been milled and cleaned. The instructions given in the section "Reprocessing" should be observed.

Thermal utilization

Observing the relevant laws, Ultrason® can be thermally utilized in an incineration plant. The safety data sheets for individual products have to be observed. Complete combustion of Ultrason® results in carbon dioxide, sulfur dioxide, and water, while traces of sulfur trioxide can occur.

Nomenclature

Structure

The nomenclature adopted for the products consists of an alphanumeric code, the key to which is given below. An appended "P" signifies that the product concerned is a specialty intended for the preparation of solutions.

1st digit (letter):

type of polymer

E = Polyethersulfone (PESU)

S = Polysulfone (PSU)

P = Polyphenylsulfone (PPSU)

2nd digit (number):

viscosity class

1 ... = low viscosity

6 ... = high viscosity

6th digit (letter):

reinforcements

G = glass fibers

C = carbon fibers

7th digit (number):

proportion of additives

2 = mass fraction of 10%

4 = mass fraction of 20%

6 = mass fraction of 30%

Example

E	2	0	1	0	G	6
1 st digit	2 nd digit	3 rd digit	4 th digit	5 th digit	6 th digit	7 th digit

e.g. Ultrason® E 2010 G6

E = Polyethersulfon (PESU)

2 = of medium viscosity

(standard injection-molding grade)

G6 = 30 % by weight of glass fibers

Product overview

PESU	PSU	PPSU	Characteristic features
unreinforced			
E 1010			low viscosity, easy-flowing (injection molding)
E 2010*	S 2010		medium viscosity, standard grade (injection molding, film extrusion, blow molding)
E 2020 P			medium viscosity (coatings, membranes, toughness modification)
E 2020 P SR			medium viscosity, with OH end groups (coatings, toughness modification of composites)
E 3010*	S 3010*	P 3010	higher viscosity, very good chemical resistance and toughness (injection molding, extrusion)
E 6020 P	S 6010		high viscosity (membrane applications)
reinforced			
E 2010 G4	S 2010 G4		20% GF; increased stiffness and strength
E 2010 G6	S 2010 G6		30% GF; increased stiffness and strength
KR 4113			medium viscosity, carbon-fiber reinforced, tribologically optimized (injection molding)
E 2010 C6			30% carbon-fiber reinforced, very high stiffness; metal substitutes (injection molding)

* these products are also available with optimized demolding properties

Table 13: Basic product range Ultrason®

Subject Index

Annealing 45
Assembly methods 42
Automotive construction 4 f.

Behavior under
– dynamic loading and flexural strength 19
– short-term mechanical loads 12 ff.
– sustained static loads 14 ff.
– the influence of temperature 21

Biological effects 46

Blanking 42

Blow molding 41

Bonding with adhesives 43

Civil engineering 30

Coating 43

Colors 34, 47

Compatibility 34

Delivery 47

Detachable connections 43

Dimensional stability 33

Electrical properties 28

Environmental 47

Extrusion 38 ff.

Fire behavior 29 f.

Food safety regulations 46

Food sector 6 f.

Friction and wear behavior 20

Household sector 6 f.

Injection mold 36

Injection molding 35 ff.

Labeling 43

Lubricants, fuels, and coolant fluids 25 ff.

Machining 42 ff.

Manufacture of

– Films 41

– Panels 40 f.

– Tubes, profiles and panels 39 f.

– Ultrason® Foam 41

Mechanical properties 12 ff.

Medical products 46 f.

Metallizing 43

Nomenclature 48

Optical properties 24

Plasticizing unit 35 f.

Postprocessing 42 ff.

Pretreatment 34

Processing 34 ff.

Product overview 49

Product range 10 f.

Properties 10 ff.

Quality management 47

Recycling 47

Reprocessing and recycling 35

Resistance to

– Chemicals 31

– High-energy radiation 32

– Thermal aging in air and water 21 f.

– Weathering 32

Safety notes 46 f.

Safety precautions during processing 46

Sawing 42

Shutdown 34

Slit die 41

Startup 34

Storage 47

Stress level 44 f.

Superheated-steam sterilization 23

Tests 29 f.

Thermal properties 21 ff.

Thermal utilization 47

Thermoforming 44

Transportation 30

Water absorption 33

Welding 42 f.

Selected Product Literature for Ultrason®:

- Ultrason® E, S, P – Product Range
- Ultrason® – Resistance to Chemicals
- Ultrason® – Products for the Automotive Industry
- Ultrason® – Injection Molding
- Ultrason® – Special Products
- Ultrason® – A Versatile Material for the Production of Tailor-made Membranes
- Engineering Plastics for the E/E Industry – Standards and Ratings
- Engineering Plastics for the E/E Industry – Products, Applications, Typical Values
- Engineering Plastics for Automotive Electrics – Products, Applications, Typical Values
- From the Idea to Production – The Aqua® Plastics Portfolio for the Sanitary and Water Industries

Note

The data contained in this publication are based on our current knowledge and experience. In view of the many factors that may affect processing and application of our product, these data do not relieve processors from carrying out own investigations and tests; neither do these data imply any guarantee of certain properties, nor the suitability of the product for a specific purpose. Any descriptions, drawings, photographs, data, proportions, weights etc. given herein may change without prior information and do not constitute the agreed contractual quality of the product. It is the responsibility of the recipient of our products to ensure that any proprietary rights and existing laws and legislation are observed. (July 2013)

Please visit our websites:

www.plasticsportal.com (World)

www.plasticsportal.eu (Europe)

Additional information on specific products:

[www.plasticsportal.eu/name of product](http://www.plasticsportal.eu/name_of_product)

e. g. www.plasticsportal.eu/ultrason

Request of brochures:

PM/K, F204

Fax: +49 621 60-49497

If you have technical questions on the products,
please contact the Ultra-Infopoint:

